



# ZODIAC

## G4

### OWNER'S MANUAL



**The following parts are included with your Zodiac G4 (Model# W83251):**

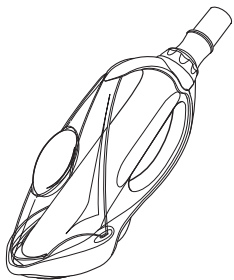

(1) Cleaner Head

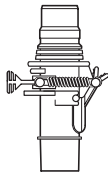

(1) FlowKeeper™ Valve

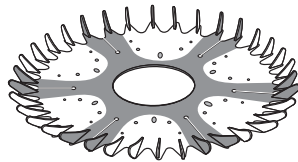

(1) Dual Durometer Disc



(1) Universal  
Valve Cuff



(2) 45 Degree Elbows



(1) Pool Pulse™



(1) Hose Weight

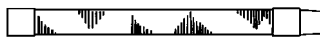

(12) Hose Lengths

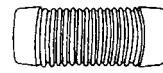

(1) 4 1/2" Connector

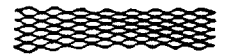

(1) Hose Protector Net



**THANK YOU FOR PURCHASING ZODIAC G4.**  
**YOUR ZODIAC G4 HAS BEEN DESIGNED AND MANUFACTURED TO BE EASILY  
INSTALLED AND TO PROVIDE YEARS OF LOW MAINTENANCE OPERATION.**  
**PRIOR TO INSTALLING YOUR NEW ZODIAC G4, PLEASE DO THE FOLLOWING:**

- 1) Complete and return the warranty card.
- 2) Record your purchase information on the spaces provided below.
- 3) Attach your invoice (or a copy) to this page.

These actions will insure prompt warranty service, should it be required. Simply present your owner's manual, along with the invoice at any of our authorized warranty centers nationwide.

**RECORD YOUR ZODIAC G4 POOL CLEANER DATA HERE:**

Date of Purchase \_\_\_\_\_ Purchased From \_\_\_\_\_ Serial Number: \_\_\_\_\_  
*(located on underside of machine head)*

City \_\_\_\_\_ State \_\_\_\_\_ Zip Code \_\_\_\_\_

## ZODIAC G4 LIMITED WARRANTY

This ZODIAC G4 was carefully inspected before shipment from our warehouse. Upon unpacking, if any part proves defective or missing, please notify Zodiac Pool Care, Inc. immediately. Please consult owner's manual for complete instructions on the installation and operation of your ZODIAC G4.

ZODIAC POOL CARE, INC. WARRANTS THE ZODIAC G4 POOL CLEANER AGAINST ALL MANUFACTURING DEFECTS AND ALL WEAR AND TEAR FOR (2) YEARS. ALL WARRANTIES ARE EFFECTIVE FROM THE DATE OF PURCHASE.

Should this product prove defective in workmanship, materials or wear during the applicable warranty period, the consumer's sole and exclusive remedy shall be such repair or replacement of the product as provided below.

**THE LIMITED WARRANTY PROVIDED HEREIN IS THE SOLE AND EXCLUSIVE WRITTEN WARRANTY WITH RESPECT TO THE ZODIAC G4 POOL CLEANER. ALL IMPLIED WARRANTIES IMPOSED BY APPLICABLE LAW, INCLUDING ANY IMPLIED WARRANTY OF MERCHANTABILITY OR FITNESS FOR A PARTICULAR PURPOSE, ARE LIMITED TO THE DURATION OF THE EXPRESS LIMITED WARRANTY. SOME STATES DO NOT ALLOW LIMITATIONS ON HOW LONG AN IMPLIED WARRANTY LASTS, SO THE ABOVE LIMITATION MAY NOT APPLY TO YOU.**

### **THIS LIMITED WARRANTY EXCLUDES THE FOLLOWING:**

1. Discoloration of the ZODIAC G4 pool cleaner. This is caused by reaction to ultraviolet rays and the chemicals used in the pool water. Discoloration does not affect the operating ability of the ZODIAC G4. Therefore, this Limited Warranty does not cover the replacement of discolored parts.
2. Damage to or malfunction of the unit resulting from excess chlorination or improper water chemistry balance.
3. Replacement of parts which fail or become defective as a result of improper installation, negligence, misuse, abuse or tampering by unauthorized repair personnel.
4. Age, pool water imbalance, and improper installation can cause vinyl pool liners to become brittle or unduly wrinkled. Corrosion of the supporting walls and/or irregularities in the pool base may also cause liner failure. The use of this product in such an environment is at the pool owner's risk. Therefore, the pool owner hereby releases the manufacturer from any and all claims for damage where these conditions exist.
5. The ZODIAC G4 is designed for use in inground pools only. If unit is used in any other application, the pool owner hereby releases the manufacturer from any and all claims. This misuse will void all warranty on the unit.
6. In no event shall Zodiac Pool Care, Inc. be liable in contract or in tort, or under any other legal theory, for lost profits or revenues, loss of use or similar economic loss, or for indirect, special, incidental, consequential or similar damages, even if it has been advised of the possibility of such claim. Some states do not allow the exclusion or limitation of incidental or consequential damages, so the above limitation or exclusion may not apply to you.

### **IMPORTANT WARRANTY NOTICES FOR VINYL LINER POOL OWNERS**

- Certain vinyl liner patterns are particularly susceptible to rapid surface wear or pattern removal caused by objects coming into contact with the vinyl surface, including pool brushes, pool toys, floats, fountains, chlorine dispensers, and automatic pool cleaners.
- Some vinyl liner patterns can be seriously scratched or abraded simply by rubbing the surface with a pool brush. Ink from the pattern can also rub off during the installation process or when it comes into contact with objects in the pool. **Zodiac is not responsible for, and the Limited Warranty does not cover, pattern removal, abrasion or marking on vinyl liners.**
- Vinyl liners are subject to deterioration or damage due to age, the effect of chemicals, corrosion or failure of the supporting walls; as well as improper installation, maintenance or cleaning of the supporting walls or base.
- Before installing the Zodiac G4, examine the interior of your pool carefully. If your vinyl liner is brittle or has stones, wrinkles, roots or metal corrosion in contact with the underside of the liner, or has damage to the base material or supporting walls, do not install the Zodiac G4 before having a qualified professional perform the necessary repairs.

**ZODIAC POOL CARE, INC. WILL NOT BE RESPONSIBLE FOR LINER DAMAGE CAUSED BY (1) A ZODIAC G4 CLEANER WHICH IS IN DISREPAIR, (2) PATTERN REMOVAL FROM A VINYL LINER, OR (3) A ZODIAC G4 CLEANER USED IN A POOL HAVING AN AGED OR DETERIORATED LINER.**

### **WARRANTY PROCEDURES**

No claim under this Limited Warranty will be recognized unless the registration card, included in your box, is completed and returned within fifteen (15) days of the purchase date. **Only the original purchaser may submit a claim under this Limited Warranty.** Purchaser's claims against Zodiac Pool Care, Inc., shall be limited to those claims which may be asserted under the Limited Warranty relating to any defect, malfunction or wear of the ZODIAC G4.

To obtain warranty replacements or repair, call (888) 786-7797 for authorization. When submitting a claim, always supply serial number, evidence of purchase date, retailer and a brief description of the problems/defects encountered. Zodiac Pool Care, Inc. reserves the right to repair or replace all defective or worn parts covered by this Limited Warranty and return same to purchaser, freight collect.

Zodiac Pool Care, Inc. assumes no responsibility for any warranties or representations made by other individuals or businesses beyond the express terms contained in this Limited Warranty.

This warranty gives you specific legal rights, and you may also have other rights which vary from state to state

For sale and use in the United States, Canada and Mexico only. This pool cleaner is not warranted or guaranteed outside of the United States, Canada or Mexico.

This pool cleaner is covered by one or more of the following U.S. and Canadian patents and Canadian registered design:

U.S. patent nos. 4642833, 4742593, 5421054, 5450645 and 5465443. Canadian patent nos. 1254105 and 1256262. OTHER PATENTS PENDING.



# ZODIAC

## INGROUND AUTOMATIC POOL CLEANER INSTALLATION GUIDE

Pool Preparation .....	2
Assembly .....	3
Hose Assembly .....	3
Balance .....	4
Removing Air From Hose.....	4
Installation .....	5
Achieving Proper Flow .....	6
Adjustments.....	7
Troubleshooting.....	7
Accessories .....	8

### HOW YOUR ZODIAC AUTOMATIC POOL CLEANER WORKS

- Your pool pump pulls water from the main drain and the skimmer through a strainer basket, then pushes the water through the filter system and back into the pool through the return inlets.
- The Zodiac Automatic Pool Cleaner connects to the skimmer or dedicated vacuum line with the hose sections provided. Water flows through the diaphragm of the cleaner at a rate of 14 to 19 gallons per minute.
- Diverting or re-directing the return inlets downward breaks up the circulation pattern of water within the pool. This allows random cleaning around the pool.
- Most common problems can be eliminated, by reading through the entire manual before installing your new Zodiac.

### POOL COMPONENTS

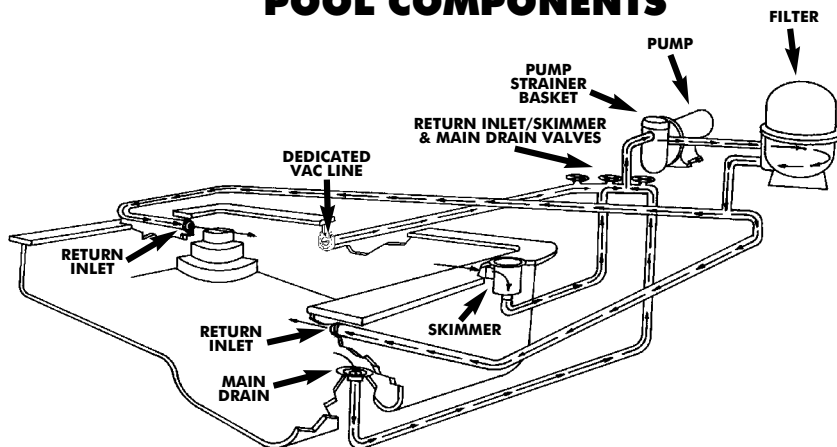

- Please become familiar with the components of your pool shown.
- All diagrams are provided for reference of terminology used throughout this manual. Your pool may vary.



Thank you for purchasing this automatic pool cleaner from Zodiac. Prior to installing your pool cleaner, review the parts and warranty information and insure that all parts shown are included with your unit.

Although the appearance of your model Zodiac Pool Cleaner may differ slightly from some drawings shown in this installation guide, installation steps remain the same.

## STEP 1 - POOL PREPARATION

- Before installing the Zodiac Automatic Pool Cleaner, examine the interior of your pool carefully. If your vinyl liner is brittle or has stones, wrinkles, roots or metal corrosion in contact with the underside of the liner, or has damage to the base material or supporting walls, do not install the pool cleaner before having a qualified professional perform the necessary repairs.
- Close the main drain. This allows the flow to be regulated by the Flowkeeper.
- Manually vacuum the pool. This eliminates unnecessary adjustment later.
- Clean the pool filter and empty the skimmer and pump strainer baskets. Filter pressure rises as debris is cleaned from the water, thus reducing flow.
- Divert the pool return inlets downward - (IMPORTANT!). Your Zodiac Automatic Pool Cleaner must move randomly throughout the pool. Water circulating at the surface will influence the hose and limit coverage.
  - To adjust the return inlet: loosen the lock ring and redirect the eyeball downward, then retighten the lock ring. If the eyeball is difficult to adjust, insert a screwdriver inside the eyeball and gently adjust downward.
  - If the return inlets cannot be pointed downward, then you **MUST** install Zodiac return line diverters. They are available through your Zodiac dealer.

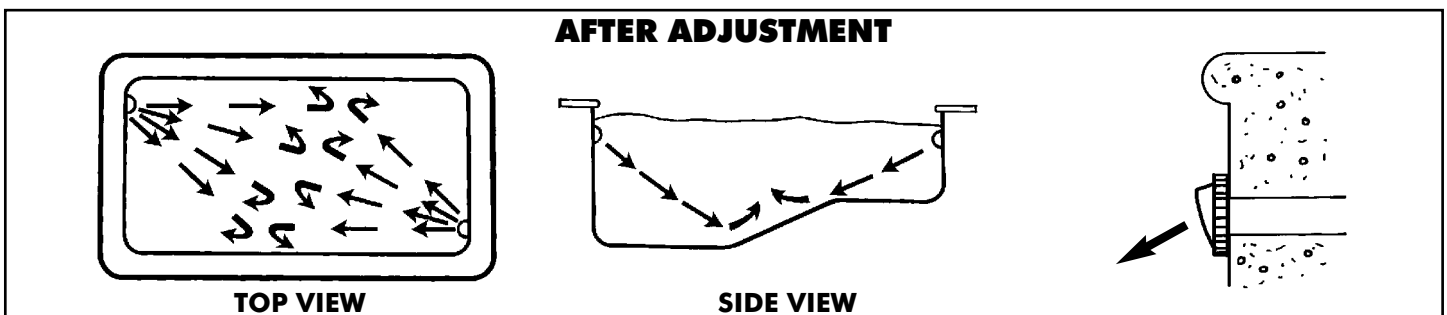
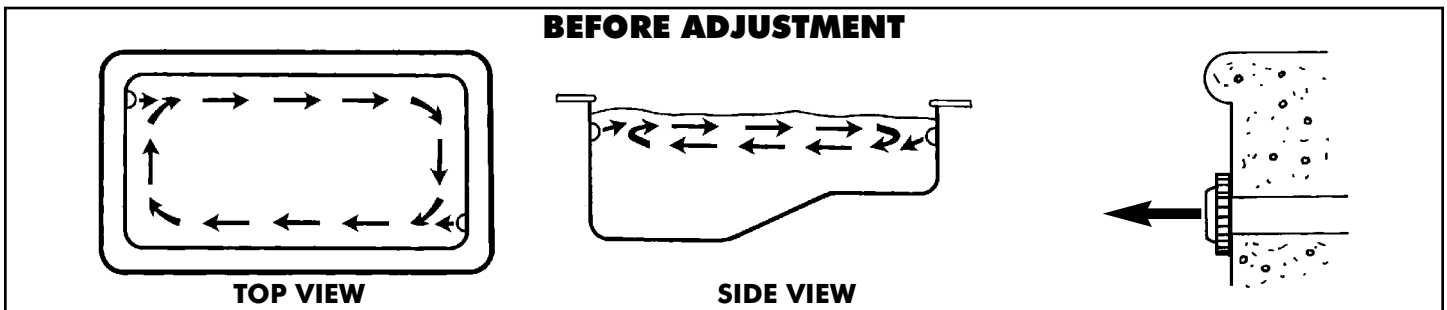

**FOR POOLS WITH RETURN INLET DIRECTIONAL FITTINGS**

Replace the directional eyeball with Zodiac retrofit eyeball return line diverter and reinstall eyeball retaining ring.

Part #W90153 for 1½" return lines

Part #W90155 for 2" return lines

**IF UNABLE TO ADJUST RETURN INLETS OR FOR POOLS WITHOUT RETURN INLET DIRECTIONAL FITTINGS**

Use Zodiac universal return line diverter (Part #W24100). Pinch wires together and insert fully into return inlet.

# STEP 2 - ASSEMBLY

## FINNED DISC INSTALLATION

Slide the finned disc over the foot pad. Insure the disc fits properly in the grooves provided and rotates freely on the foot pad. **The fins on the disc face upward.**

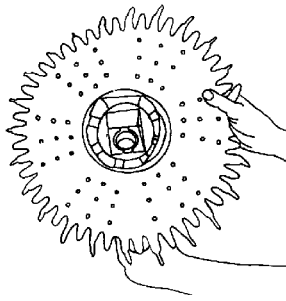

**BOTTOM VIEW**

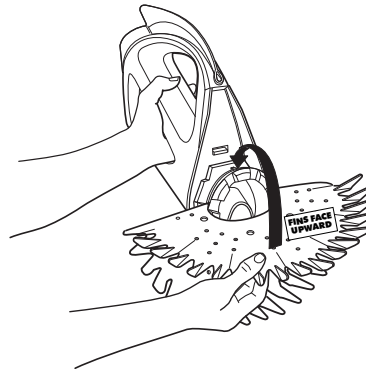

**REAR VIEW**

## WHEEL DEFLECTOR INSTALLATION (Only used on some pool cleaners.)

Some Zodiac Pool Cleaner models require a wheel deflector for proper performance. If your model includes one, slide the wheel deflector over the extension pipe and secure between the two lowest pipe ridges. Make sure the top clips of the wheel deflector are seated in the groove. The wheel deflector should rotate freely.

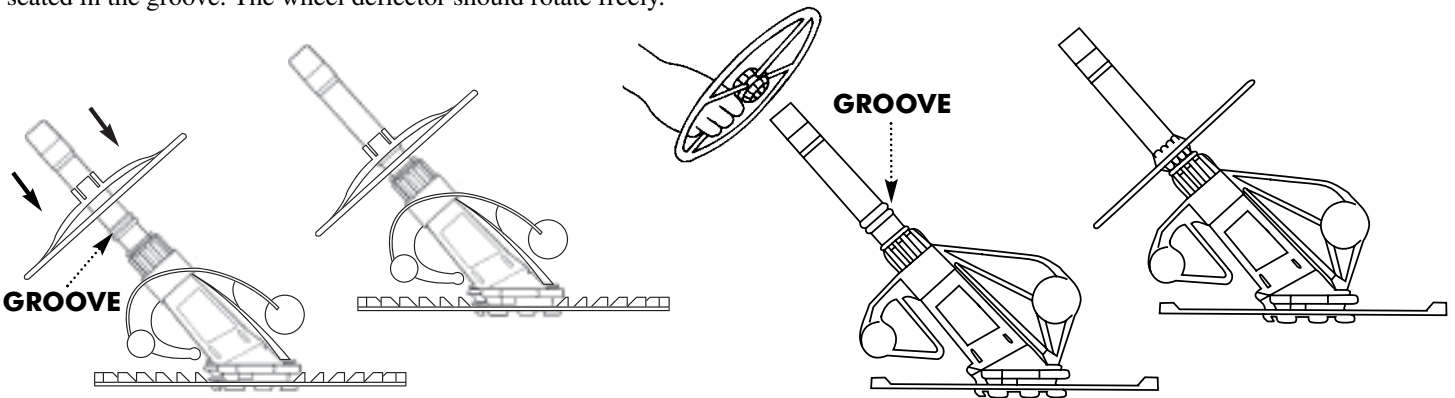

# STEP 3 - HOSE ASSEMBLY

## FOR CORNER OR END INSTALLATIONS

If your skimmer or wall vacuum fitting is located at the corner or end of your pool, use enough hose sections to reach the farthest point in the pool, plus one (1) section.

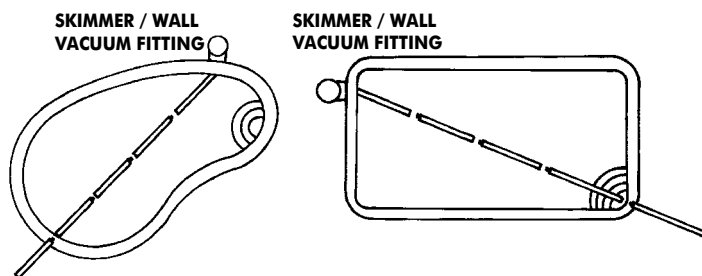

## FOR CENTER INSTALLATIONS

If your skimmer or wall vacuum fitting is located at the center of your pool, use enough hose sections to reach the farthest point in the pool, plus two (2) sections.

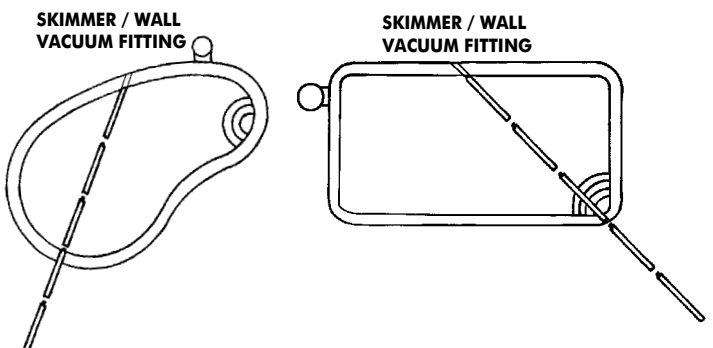

**Note:** You may not need to use all **or** you may need more hose sections, with either installation method, depending upon your pool size.

# STEP 4 - BALANCE

Zodiac Automatic Pool Cleaners require a specific number of hose weights to compensate for the buoyancy of the hose depending on the cleaner model. A properly balanced pool cleaner hose will create a 45-degree angle from the cleaner head and the bottom of the pool as shown below.

**FOLLOW THE GUIDELINES BELOW FOR YOUR SPECIFIC CLEANER MODEL.  
(Model number is stated on the cover of the manual.)**

**MODEL# W83251** - Hose weight is not required for this model cleaner in most pools. As a troubleshooting technique to improve coverage or prevent the cleaner from climbing the walls excessively, snap (1) hose weight onto the first hose section, one meter from the cleaner head.



**MODEL# W03000** - Snap (1) hose weight onto the middle of the first hose section, 1/2 meter from the cleaner head.



**MODEL# W83215 & W83216** - Snap (2) hose weights onto the middle of the second hose section, 1 1/2 meters from the cleaner head.

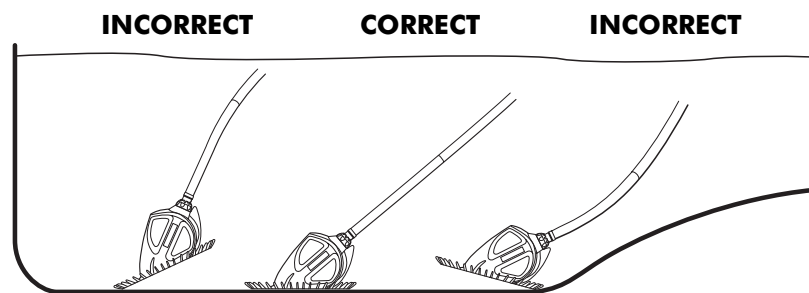

**Note:** For pools 8 1/2 feet or deeper, please refer to page 7 of this manual for balancing instructions.

# STEP 5 - REMOVING AIR FROM HOSE

- Turn the filtration system off.
- Attach the cleaner head to the female end of the hose.
- Turn on the filtration system.
- Fill the hose with water by placing the end over a return inlet.

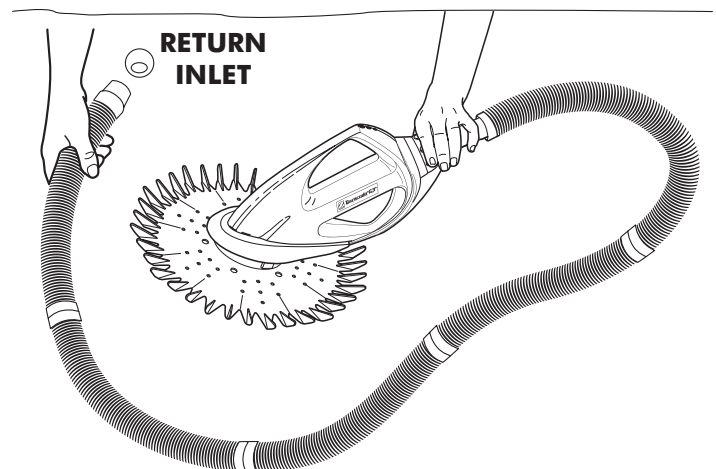
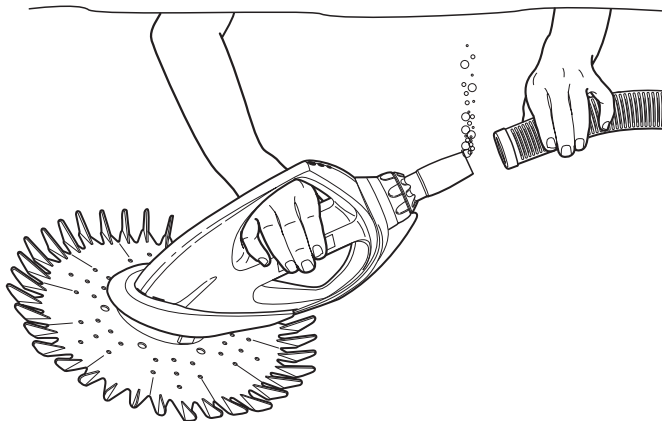

# STEP 6

## INSTALLATION FOR POOLS WITH SKIMMERS

### FLOWKEEPER VALVE

In skimmer installations the Flowkeeper Valve **MUST BE** used. The pool pump provides more gallon per minute flow than your pool cleaner requires. The Flowkeeper provides a way to regulate the flow with a bypass so the pool pump and the pool cleaner run properly.

Skimming action is maintained through a bypass throat in the valve. As the filter collects debris, the valve automatically maintains the correct flow to the cleaner. The Flowkeeper Valve comes preset at the setting required for your cleaner. There are a total of three setting options. The lower the setting number, the lower the flow to the cleaner head. Should readjustment become necessary, pull the adjustment handle to raise or lower the setting. The red tab on the valve can be used to keep the bypass open, which in most cases, will cause the cleaner to stop.

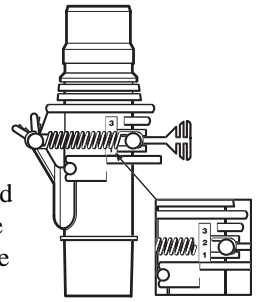

**A**

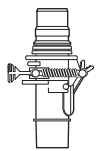

(1) Flowkeeper Valve

**B**



(1) Valve Cuff

**C**

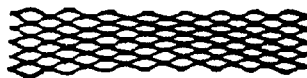

(1) Hose Protector Net

**D**



(1) 4 1/2" Connector

**E**



(2) 45° Elbows

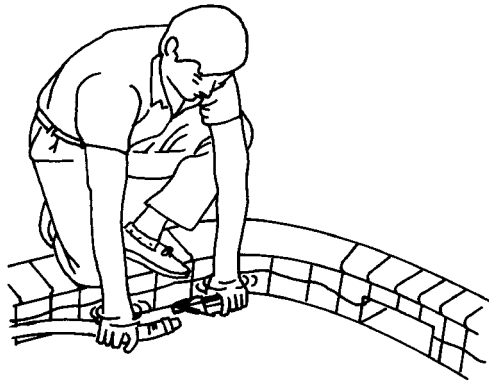

**Example 1**

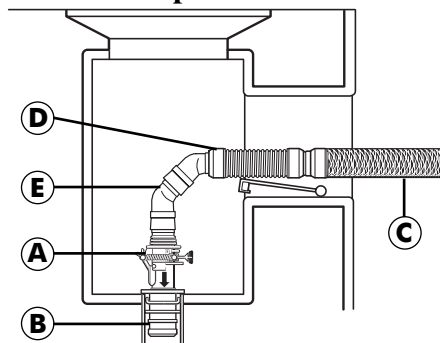

**Example 2**

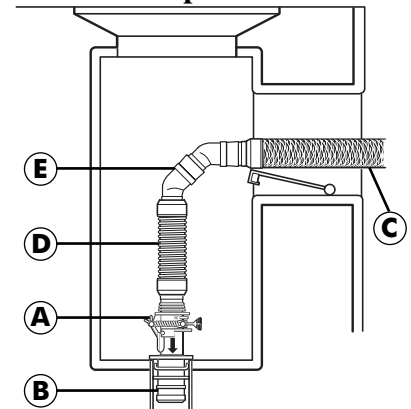

**Arrow on Flowkeeper must be pointed downward, toward skimmer.**

- Using the parts shown, choose a fitting combination best suited for your skimmer. You may have parts left over.
- Attach the hose protector net (C) to the hose section that goes into the skimmer.
- Remove the skimmer basket, attach the Flowkeeper Valve combination to the hose with protector net, and install into the skimmer as shown in example 1 or 2. Turn on the filtration system. **Continue to STEP 7.**

**Note:** For pools with multiple skimmers, connect the Flowkeeper Valve combination to the skimmer closest to the plumbing manifold.

## INSTALLATION FOR POOLS WITH DEDICATED VAC LINE

### NO FLOWKEEPER VALVE REQUIRED

- Insert the male end of the hose into the large end of the 45° Elbow.
- Insert the small end of the 45° elbow into vac lock and angle the 45° elbow toward the pool surface. **Continue to STEP 7.**

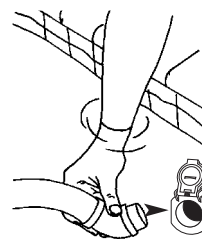
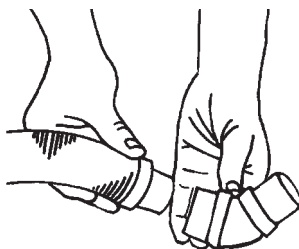

**Important:** To help prevent suction entrapment accidents, wall vacuum fittings should have a safety vac lock installed. Contact your builder or retail pool professional for details.

# STEP 7 - ACHIEVING PROPER FLOW

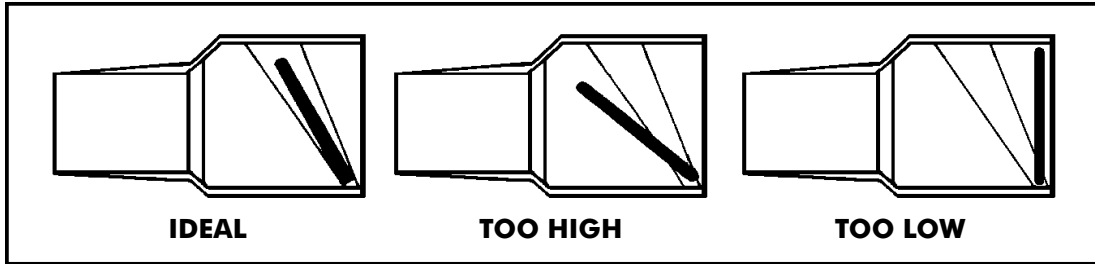

## POOL PULSE®

The Pool Pulse is a flow meter that measures the volume of water flowing through your Zodiac cleaner. It must be used to properly set the flow and can be used as a diagnostic tool when the cleaner isn't running properly.

For the following steps, using 2 people is recommended; one poolside and the other at the plumbing manifold. Vacuum and skimmer valves are located at your plumbing manifold.

- Remove the cleaner head.
- Attach the Pool Pulse® to the end of the hose and keep it under water as shown in Figure 1.
- Turn on the filtration system.
- **For pools with one skimmer**, flow is automatically regulated by the Flowkeeper Valve. Insure the blue indicator of the Pool Pulse is in the ideal range (when viewed from the side).
- **For pools with two or more skimmers**, leave the selected skimmer open and slowly close the other skimmer(s) until the blue indicator of the Pool Pulse moves into the ideal range (when viewed from the side).
- **For pools with a wall vacuum fitting**, leave the wall vacuum fitting fully open and slowly close the skimmer valve until the blue indicator of the Pool Pulse moves into the ideal range (when viewed from the side).
- Keeping the hose under water, remove the Pool Pulse. Submerge the cleaner head, and when the bubbles stop coming from the extension pipe, attach the hose end. **Your installation is now complete.**

## SAMPLE PLUMBING MANIFOLD

NOTE: Plumbing manifolds vary by pool. Refer to your pool builder for questions regarding your plumbing manifold configuration.

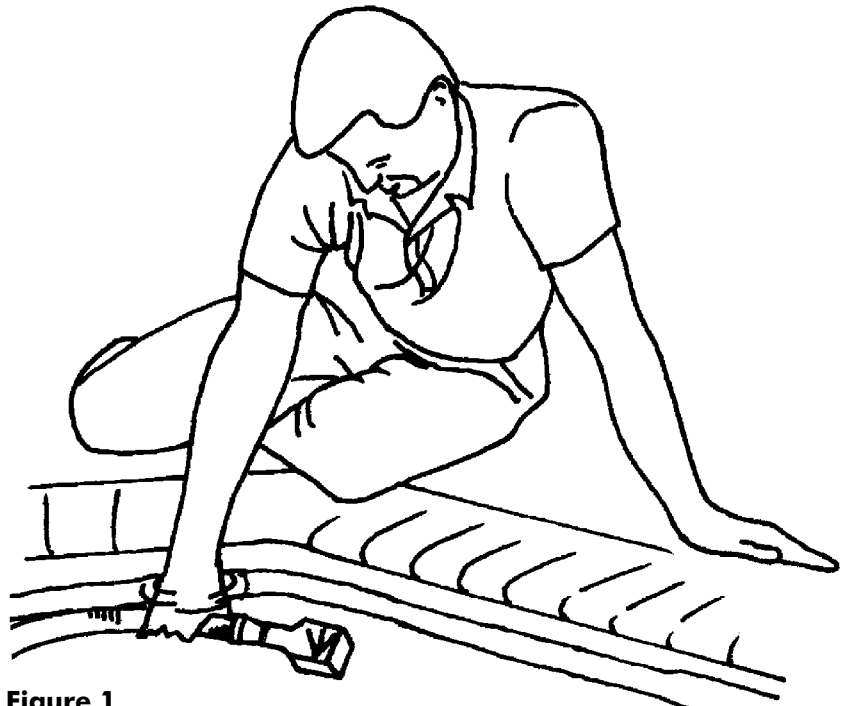
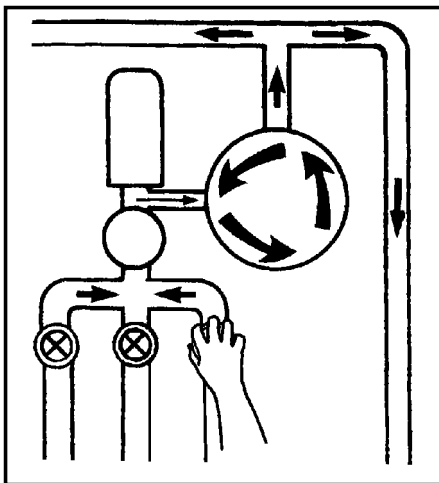

Figure 1

**If the flow is in the low range**, review the installation procedures. A dirty pool filter, clogged baskets and improperly set valves are usually the main cause of low flow. Other types of hydraulic problems may require a professional pool repairman.

**If the flow is in the high range**, review the installation procedures. Confirm that the valves controlling these lines are properly set. Lower the setting on the Flowkeeper Valve. Slightly open the main drain as a last option if flow is still excessive.



# ADJUSTMENTS

## BALANCE - POOLS THAT ARE 8 1/2 FEET OR DEEPER

### FOLLOW THE GUIDELINES BELOW FOR YOUR SPECIFIC CLEANER MODEL.

**MODEL# W83251** - Snap (1) hose weight onto the first hose section, one meter from the cleaner head.

**MODEL# W03000, W83215, and W83216** - An additional hose weight (#W83247) may be necessary to balance the Zodiac Pool Cleaner head. If the cleaner is not balanced correctly in the deep end of the pool (as shown on page 4), turn off the pump and add an additional hose weight approximately 5 to 8 feet away from the cleaner head. Place the pool cleaner in the deep end, turn on the pump and determine whether the correct balance has been achieved. If not, re-position the additional hose weight accordingly. Additional hose weights may be purchased from your Zodiac dealer if required.

## IMPROVING COVERAGE

Normally it is undesirable for the return line water flow to affect the natural movement of the pool cleaner hose. However, the following illustration shows how return line pressure can be used to balance cleaning coverage or to guide the cleaner away from step areas with "V" shaped corners.

A return line located anywhere along the shaded area can be utilized to gently push the hose allowing the pool cleaner to free itself from in-pool obstacles.

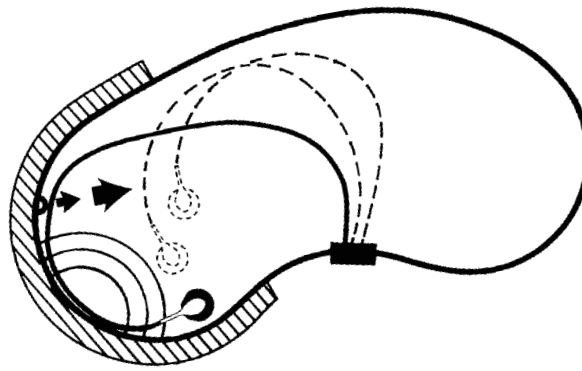

### Technique

Position the return line directional so that you can only detect water movement on the surface 8 feet out from the wall, and aim it at the center of the opposite wall.





## TROUBLESHOOTING

PROBLEM	SOLUTION
Cleaner stops & starts	Check diaphragm for blockage or damage. Use Pool Pulse® to determine proper flow.
Cleaner is patterning	Add return diverters or divert return inlets downward. Lay hose in a straight line in the sun to relax memory. Confirm proper hose length - add 1 to 2 hose sections.
Cleaner isn't covering opposite end of pool	Add return diverters or divert return inlets downward. Use flow to move cleaner to opposite end. Move hose weight away from cleaner head slightly. In deep pools add additional weight.
Cleaner stuck at steps	Utilize return flow (see adjustments). Confirm proper hose length. Adjust flow to cleaner. Adjust hose weight. Install wheel deflector.
Cleaner stuck under ladder	Install ladder guard (#W24000).
Cleaner flips over	Contact tech services for local warranty station.
Cleaner won't climb walls	Cleaner may not climb walls of some vinyl pools. Use Pool Pulse and raise flow. Confirm proper hose length. Adjust hose weight.
Cleaner doesn't move	Use Pool Pulse to insure proper flow. Clean baskets & filter. Check diaphragm for damage. Check hose sections for leaks by lifting each section above water.
Cleaner won't leave edge or rim of pool	Use Pool Pulse to lower flow. Utilize return flow to move cleaner. Adjust hose weight.
Solar blanket installation	Coverage will be limited due to blanket.

**NOTE: In cold water of 60° or less, water flow through the cleaner must be increased to compensate for the reduced flexibility of the hose and diaphragm.**

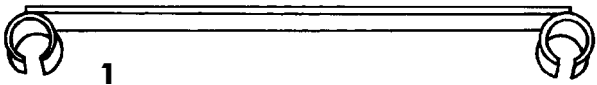
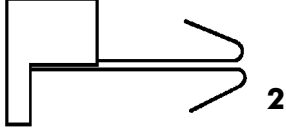
**IF ASSISTANCE IS REQUIRED, PLEASE CALL US AT 1-888-786-7797**

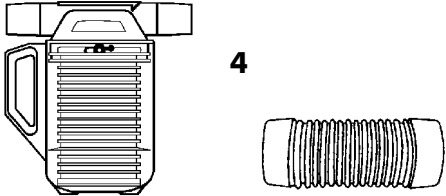
# ZODIAC ACCESSORIES

PART ILLUSTRATION	PART NO.	DESCRIPTION
	1. W24000	<b>Ladder Guard</b> Always use on stainless steel in-pool ladders
	2. W24100	<b>Return Line Diverter</b> Use when no other return inlet directional fittings exist.
	3A. W90153 (for 1 1/2" return inlet)  3B. W90155 (for 2" return inlet)	<b>Retrofit Eyeball Return Line Diverter</b> Use to replace standard directional inlet eyeballs.
	4. W26705	<b>The Leaf Catcher with 4 1/2" Hose Connector</b> Use when heavy debris or leaf situations exist.
	5. W83247	<b>Additional 37g Hose Weight</b> May be required to properly balance the Zodiac cleaner head.

## ZODIAC POOL CARE, INC.

2028 N.W. 25th Avenue  
 Pompano Beach, FL 33069  
 1-888-786-7797  
[www.zodiacpoolcare.com](http://www.zodiacpoolcare.com)

# ZODIAC G4 CARE AND MAINTENANCE

To maintain quality, performance and increase the lifespan of your Zodiac G4, please do the following:

1. Thoroughly clean the skimmer basket, pump basket and pool filter on a regular basis. **Always disconnect the hose from the skimmer before backwashing.**
2. **REMOVE THE CLEANER BEFORE SUPER CHLORINATING OR ADDING POOL CHEMICALS.** Reinstall the Zodiac G4 when the imbalance is corrected or after a minimum of 4 hours from super chlorination. Chemical damage is not covered under warranty.
3. **NEVER COIL THE HOSE** when the cleaner is removed from the pool. A coiled hose can be straightened with hot water or by laying it on a warm pool deck for several hours.

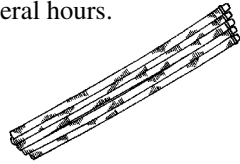

**CORRECT**

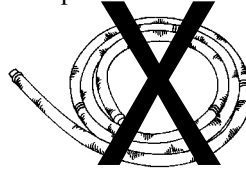

**INCORRECT**

4. Periodically inspect parts for wear. The footpad and disc are the most critical. When the depth of the channels between the treads of the footpad are 1/8" or less, replace the footpad.

## Quick Access Cassette System

Foreign objects, such as children's toys, tree branches and rocks, should be removed manually from your pool prior to operating your Zodiac G4. If a blockage should occur, the Quick Access Cassette System will allow you to check the diaphragm for damage and remove the blockage in minutes at poolside.

### DIAPHRAGM REMOVAL

Unscrew cassette (Step 1) and remove from head (Step 2). Loosen swivel pipe (Step 3). Pull out diaphragm & inner pipe (Step 4). Pull diaphragm from inner pipe (Step 5) and inspect for blockage or cuts. Remove blockage and rinse. Do not use sharp objects as damage to diaphragm may occur. If replacement parts are needed, contact technical service at 1-888-786-7797 for an authorized warranty station.

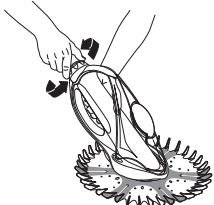

**Step 1**

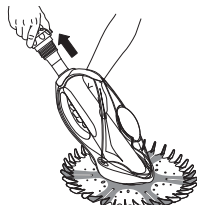

**Step 2**



**Step 3**

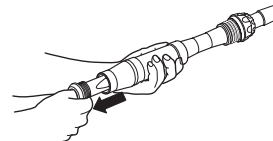

**Step 4**

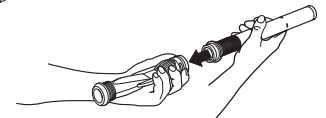

**Step 5**

### DIAPHRAGM ASSEMBLY

Prior to reinstalling the diaphragm, rinse the diaphragm and the inner extension pipe thoroughly to remove any grit or algae. Be sure the retaining ring is on the diaphragm, then push diaphragm onto inner pipe (Step 6). Insert inner pipe into diaphragm chamber and seat diaphragm against lip (Step 7). Tighten cassette assembly (Step 8). Insert cassette into head (Step 9) and tighten handnut (Step 10).

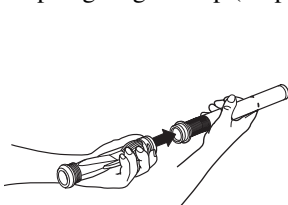

**Step 6**

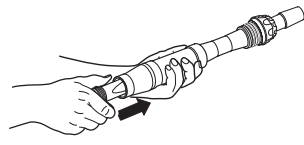

**Step 7**

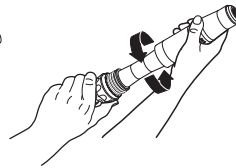

**Step 8**

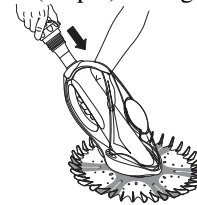

**Step 9**

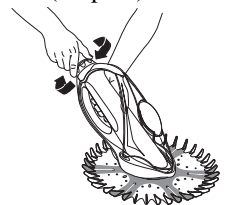

**Step 10**

### REPLACING THE FOOT PAD

Unthread and remove the cassette (Steps 1 & 2). Holding the Zodiac G4 as shown (Step 3), lift the clip while pulling the foot flange toward you. Pull off the old footpad and stretch on the new one. Line up both sides of the foot flange with the grooves of the opening, and push forward to lock into place (Step 4). Insert the cassette and tighten (Step 5).

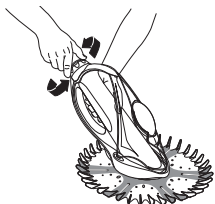

**Step 1**

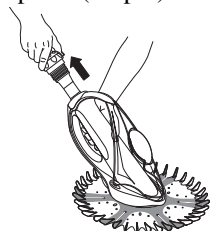

**Step 2**

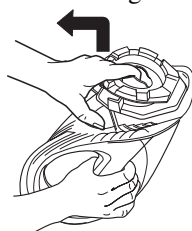

**Step 3**

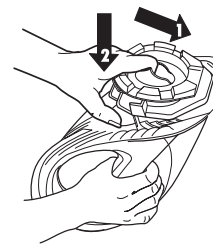

**Step 4**

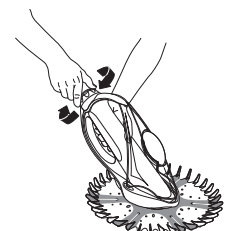

**Step 5**

# ZODIAC G4 PARTS DIAGRAM

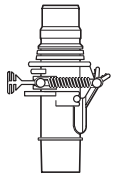

18

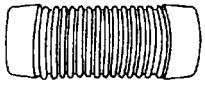

19

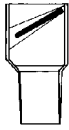

20



21



22

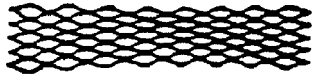

23



24

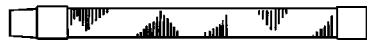

25

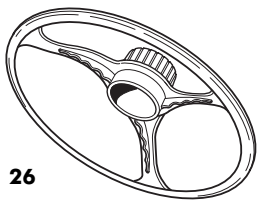

26



3

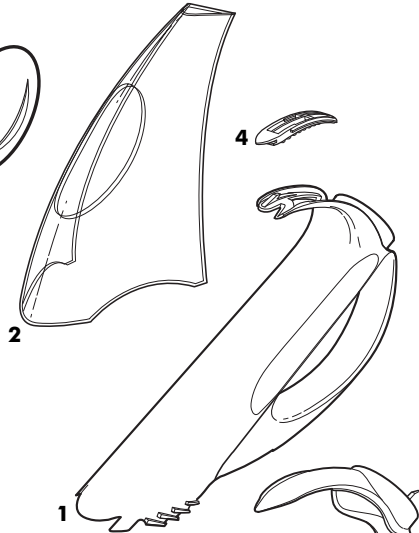

2

4

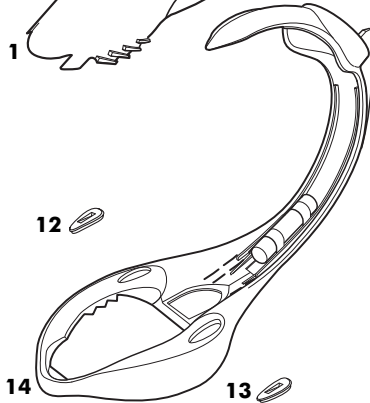

14

13

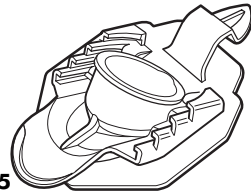

15



16

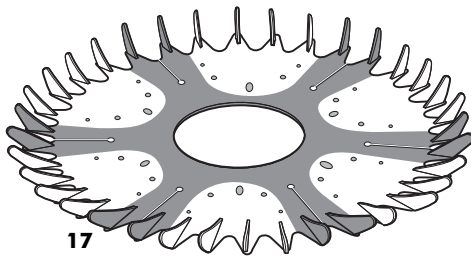

17

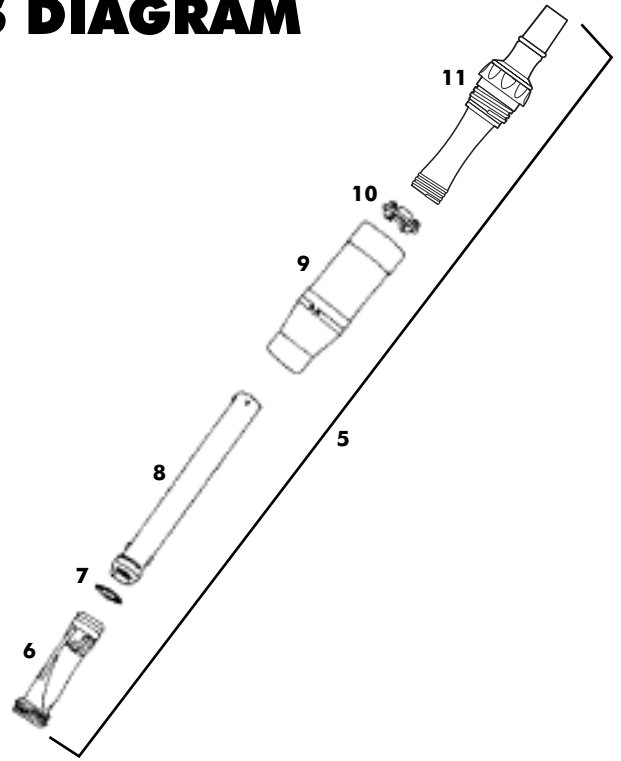

PART NO.	DESCRIPTION	QTY.
1.	W83262 Hull	1
2.	W83261 Sail	1
3.	W83268 Buoy	1
4.	W83264 Cleat	1
5.	W83325 G4 Cassette Assembly Complete	1
6.	W69698 Long Life Diaphragm	1
7.	W81600 Retaining Ring	1
8.	W56525 Inner Ext. Pipe - Natural	1
9.	W83276 Cassette Chambers Upper and Lower	1
10.	W74000 Compression Ring	1
11.	W83271 Cassette Outer Extension Pipe	1
12.	W83265 Fender - Left	1
13.	W83266 Fender - Right	1
14.	W83360 Fairing with Rudder	1
15.	W83263 Foot Flange	1
16.	W83275 Foot Pad	1
17.	W83277 Dual Durometer Disc	1
18.	W60050 FlowKeeper Valve	1
19.	W33160 4 1/2" Connector - Aqua	1
20.	W44800 Pool Pulse®	1
21.	W91046 45° Elbow	1
22.	W63900 Inground Valve Cuff	1
23.	W33800 Hose Protector	1
24.	W83247 Hose Weight	1
25.	W83140 Long-Life Hose Kit - 12x1 Meter	1
26.	W83278 Wheel Deflector (Optional Accessory)	1

## ZODIAC POOL CARE, INC.

2028 N.W. 25th Avenue  
Pompano Beach, FL 33069

1-888-786-7797

www.zodiacpoolcare.com