

55-0000ST-BK
INSTRUCTIONS

STORM COMMERCIAL REEL SYSTEM FOR INGROUND POOL

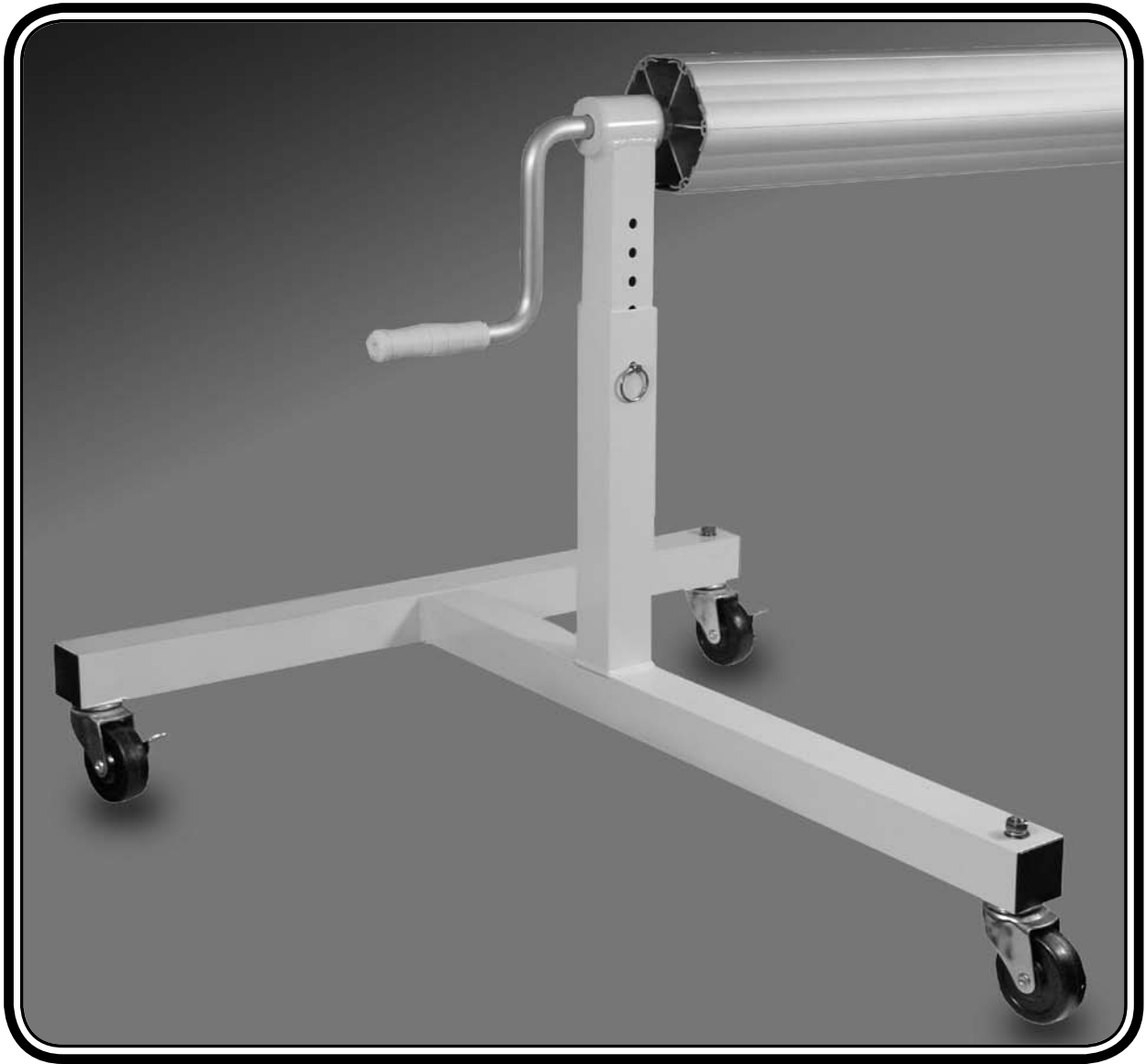

REGISTER WARRANTY ONLINE AT WWW.GLIPOOLPRODUCTS.COM.
PLEASE REGISTER WITHIN 10 DAYS OF PURCHASE.

IF YOU WISH TO MAKE A CLAIM, CALL TOLL FREE 1-800-448-2343.
FOR REPLACEMENT PARTS FOR YOUR REEL SYSTEM PLEASE VISIT, WWW.GLIPROMOTIONS.COM.



Youngstown, Ohio 44510 • www.glipoolproducts.com

INSTALLATION INSTRUCTIONS

- CONGRATULATIONS** on your purchase of our PRO SERIES Solar Reel for Inground Pools. Please follow the instructions carefully so as to not void warranty.
- Please use your solar blanket and reel assembly in the manner it was intended for:
 - Your solar blanket is not a safety cover
 - Remove the solar blanket and Solar Reel assembly from the pool completely before swimming use.
 - Do not store the solar blanket on the ground in direct sunlight, as it will burn the lawn
- Preparation & Assembly: Check inventory of all items and assemble as illustrated below:

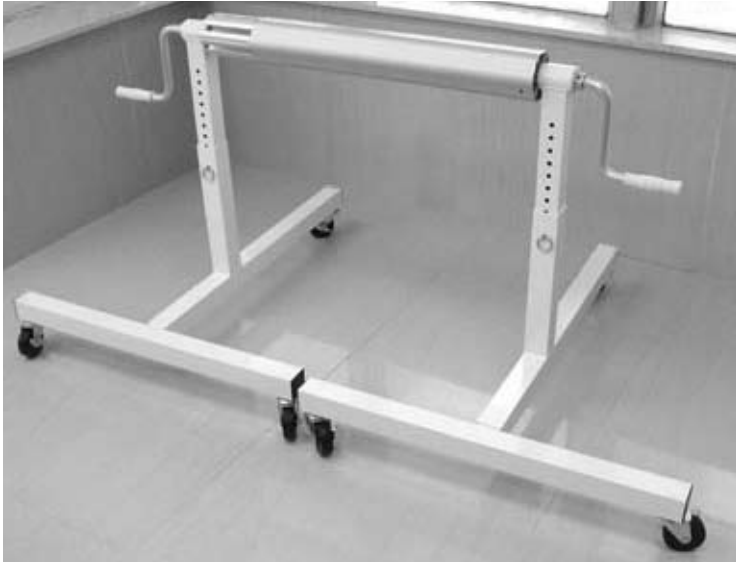

PARTS BREAKDOWN			
PART NUMBER	DESCRIPTION	QUANTITY	
1	99-55-4395008	Crank Handle with Collar	1
2	99-55-4395041	32" Stand	2
3	99-55-4395042	15" Adjustable Base Post w/ Bearing	2
4	99-55-4395043	30" Stabilizer	2
5	99-55-4395044	3" Castor	6
6	99-55-4395051	Rubber Feet	6
7	99-55-4395032	Quick Release Pin	2
8	99-55-4395020	Wrenches (for castor assembly)	2
9	99-55-4395048	Bolt w/ washer & lock washer	2
10	99-55-4395049	Large Allen Wrench	1
11	99-55-4395010	Small Allen Wrench	1
12	99-55-4395015	Strap Kit	
13		Plastic Plate	21
14		Plastic Screw	11
15		60" Fabric Strap	10
16		#304 SS hex head self drill screws	11
17		Hex head driver bit	1

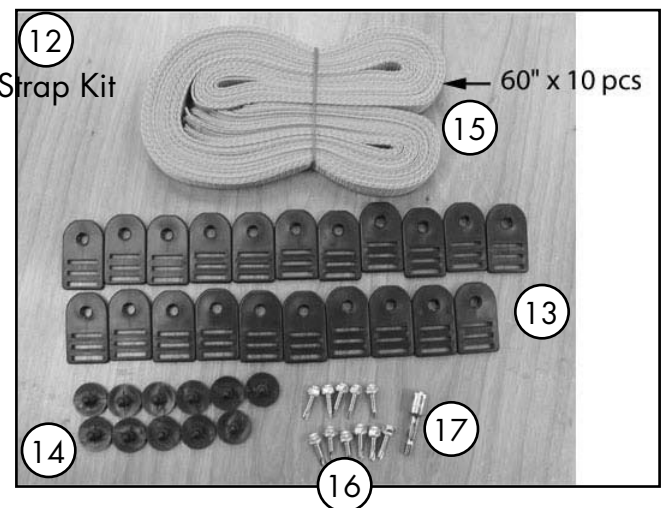
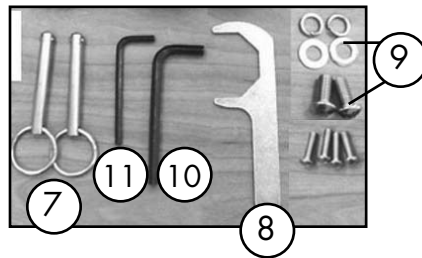
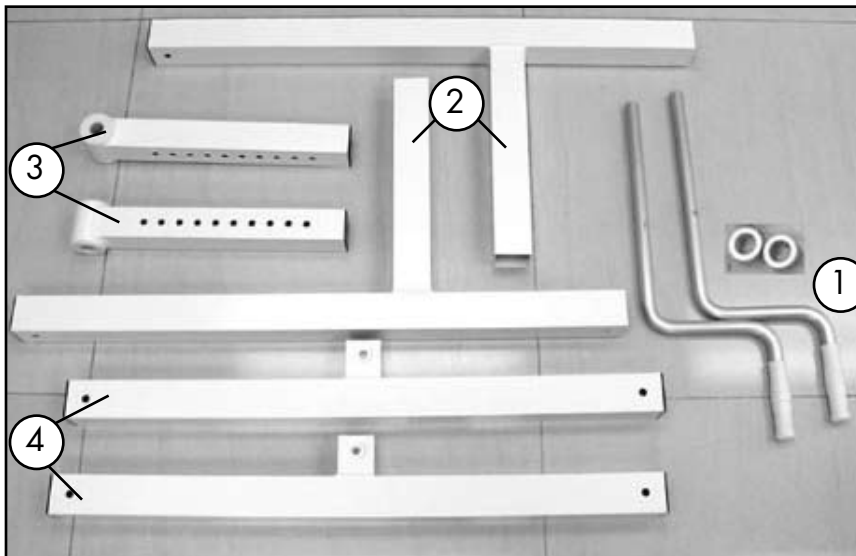

4. Depending upon the size of your pool you will also require one of the following tube kits: (Tube Assembly is detailed below)

<u>PART # 55-2004IG-TK</u> <u>20' X 4" TUBE KIT</u>	<u>PART # 55-2404IG-TK</u> <u>24' X 4" TUBE KIT</u>	<u>PART # 55-2005IG-TK</u> <u>20' X 5" TUBE KIT</u>	<u>PART # 55-2405IG-TK</u> <u>24' X 5" TUBE KIT</u>
(3) 59.5" x 3.75" Dia. Inner Tube (2) 59.5" x 4.0" Dia. Outer Tube (8) 4" Through Bolt with Nut (2) 3.75" Axel Bolt with Nut (2) 4" Aluminum Insert (2) 4" Resin Insert (1) Drill Bit Maximum length = 21' 3/4"	(3) 68" x 3.75" Dia. Inner Tube (2) 68" x 4.0" Dia. Outer Tube (12) 4" Through Bolt with Nut (2) 3.75" Axel Bolt with Nut (2) 4" Aluminum Insert (2) 4" Resin Insert (1) Drill Bit Max. finished length = 25' 3/8"	(3) 59.5" x 4.75" Dia. Inner Tube (2) 59.5" x 5.0" Dia. Outer Tube (2) 4.80" Through Bolt with Nut (8) 5.12" Axel Bolt with Nut (2) 5" Aluminum Insert (1) Drill Bit Max. finished length = 21' 3/4"	(3) 68" x 4.75" Dia. Inner Tube (2) 68" x 5.0" Dia. Outer Tube (2) 4.80" Through Bolt with Nut (12) 5.12" Axel Bolt with Nut (2) 5" Aluminum Insert (1) Drill Bit Max. finished length = 25' 3/8"

5. Positioning Your Solar Reel:

For Rectangular pools, place Stands at either end of pool. (See Fig. A)

For Irregular shaped pools, place Stands at some convenient midway point. You will need to fold Blanket and allow Blanket to unroll in two directions. (See Fig. B)

Fig. A

RECTANGULAR

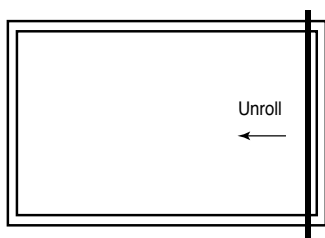
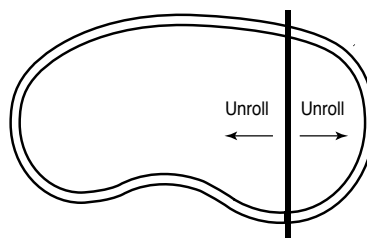

Fig. B

IRREGULAR



6. Trimming Your Solar Blanket:

- Lay your Solar Blanket (not provided) on top of water. **IMPORTANT!** Irregular Shaped Pools will need to have their solar covers folded at point of placement of Stands! The cover will unroll left and right of Stands & cross pole. Please allow 6 inches more material on length to allow for a fold where straps will be attached for wind onto reel system. (See Fig. B above)
- With scissors trim blanket to fit shape of pool. Be sure to clear pool edge coping.

7. Assembling The Tube Kit:

All Tube Sets consist of 6 sided Hexagon shaped aluminum tubing. There are two diameters of tubing, the smaller size nesting into the larger size. All Tube Kits Begin and End with Small Tubes. The Tube Insert Requires CAREFUL ALIGNMENT!

Image 1



Image 2



Image 3



Image 4



Image 5



Image 6



Image 7



Image 8



Image 9



BASE KIT ASSEMBLY:

1. Attach the 32" Stand (2) to the 30" Stabilizer using the Bolt, Lock Washer, and Washer (9). Tighten with the large Allen Wrench (10) provided. (See Image 1 & Image 2)
2. After the base is assembled, turn the unit over and install either the rubber feet (6) or the 3" Castors (5). The Rubber Feet should be used if the unit is to remain stationary. The 3" Castors must be tightened with the Wrench (8) provided and will allow the unit to be mobile or lock into place when desired. (See Image 3, Image 4, Image 5)
3. Turn the unit right side up and install the Adjustable Base Post w/ Bearing into the top of the unit. This can be adjusted vertically to suit the needs of the pool. Once the desired height is determined, secure the Post with a Quick Release Pin (7). (Image 6 and Image 7)

TUBE KIT ASSEMBLY:

- a. All tube kits consist of hexagon shaped aluminum tubing. There are two diameters of tubing; the smaller diameter will insert into the larger diameter.
- b. Determine length of tube required for your installation. Note maximum finished length per tube kit size listed above. (In Step 4)

Please note: Smaller diameter tube will be used on both ends of the reel and will connect to the base unit. Two of the smaller diameter tubes will have predrilled axle bolt holes on one end. The pre-drilled end will be connected to the base unit. (Image 8)
- c. Loosely assemble tubes together to match the desired length for your installation, evenly dividing the excess at each connection. Note that the smaller diameter tube must be inserted a minimum of 9" into the larger diameter tube at each connection. Tip: Measure in 9" from end of smaller diameter tube and make a mark with a pencil. (Image 9) The tube must be inserted at least to your pencil mark. It is ok if tube is inserted more than 9", but not less.

Image 10

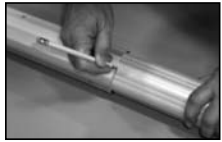

Image 11

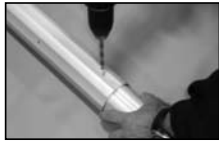

Image 12

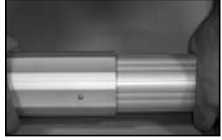

Image 13



Image 14



Image 15



Image 16



Image 17

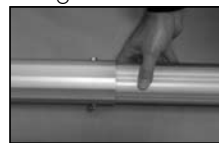

Image 18



Image 19



Image 20



Image 21



Image 22



- d. Once you determine length and have proper spacing of tubes, mark each tube at the connection point for reference. (Image 10) This will eliminate the need to re-measure if your tubes get moved during the remainder of the installation process.
- e. Each connection will be fastened together with the through bolts supplied in your tube kit. Use the pre-drilled holes in the larger diameter tube as a guide to drill the smaller inner tube. (Image 11) Twist tubing to remove excess play prior to drilling holes. (Image 12 - Before Twisting, Image 13 - After Twisting) (Fig.C on last page) Drill from each side with the drill bit supplied. (Image 14)
- f. Fasten with 2 bolts and nuts at each connection. (Image 15, Image 16, Image 17)

4" DIAMETER TUBE KITS:

Note: The 4" tube kit is packaged with two large aluminum inserts and two resin inserts. See pictures of each. (Image 18) You will use the large aluminum inserts for your installation.

- a. The resin inserts should be discarded as they will not be used.
- b. The aluminum tube insert must be inserted into the end of the tube. (Image 19) Be sure to align axle hole in the tube insert with the pre-drilled axle hole on the tube.
- c. Insert Crank handle through the base unit and into the tube insert. (Image 20) Be sure to align axle hole.
- d. Fasten tube kit to base unit using axle bolt. (Image 21) 4" tube kit uses 3.75" axle bolt. 5" tube kit uses 4.80" axle bolt.
- e. Align and tighten locking collar with allen wrench. (Image 22)
- f. Repeat same procedure on opposite end.

FOR A 5" TUBE KIT PLEASE FOLLOW ABOVE INSTRUCTIONS.

8. Attach Straps to Tubes:
Come in 6 inches from each tube end and attach a strap plate to the aluminum tube assembly. Use the self drilling screws on the drill line to attach the plate. Look at the holes that were pre-drilled at the factory and use the same drill line. There are 6 lines on each tube. Take the remaining strap plates and connect them evenly along the length of the tube assembly. Attach Straps to strap plate. (Fig. D)
9. Attach Solar Blanket to Straps:
If Reel is to be placed at the end of the pool, attach cover to strap plate with plastic screw. (Fig. E) If Reel is to be placed in offset position, then attach cover to strap plate forming a fold to act like a hinge and the plastic screw will go through two layers of the solar blanket. (Fig. F) **BUBBLES SHOULD FACE DOWN.**

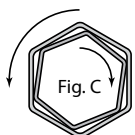

Twist Tubing To Remove Excess Play Prior To Screwing Together.

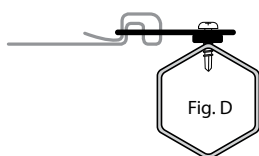

Thread Strap as Shown

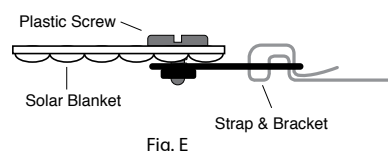

Fig. E

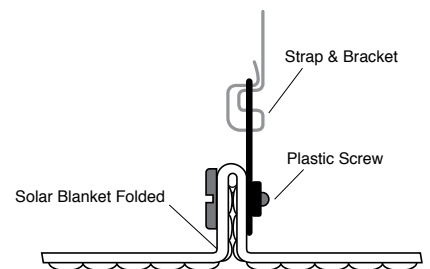

Fig. F

GLI
Pool Products

Youngstown, Ohio 44510 • www.glipoolproducts.com