

OPERATION AND INSTALLATION MANUAL

Table of Contents

PE-22

	Page
Important	2
Alarm Placement	3
Pool Side Alarm Transmitter Assembly	4
Battery Installation	5
Low Battery Indicator	5
Pool Side Alarm Mounting, Ladder Mount	6
Pool Side Alarm Mounting, Deck Mount	6
Turn The Unit ON	8
Turn The Unit OFF	8
Reset The Unit After Alarm Sounds	9
Sensitivity Adjustment	10
Alarm Unit Function Test	11
PIR (Passive Infra Red) Sensor	12
PIR Detection	13
PIR Sensitivity Adjustment	13
Reset The PIR	14
Safety Mode -- Regular	15
Safety Mode -- Enhance	15
RF (radio frequency) Signal Link Testing	16
Transmitter Channel A/B Select	17
Remote Receiver	18
LED Indication	18
Receiver Channel A/B Select	19
Language Select	19
Speaker Volume	20
Back Up Power	20
How To Connect To Your Home Security System	21
Trouble Shooting	22
Winterizing	24

IMPORTANT-Please read first

Congratulations on your purchase of the most advanced and affordable technology available for protecting your pool.



WARNING!

This product does not replace the need for adult supervision of all persons in the pool area. It is not a life saving device. It is an aid to a multi-level program of pool safety including adult supervision, knowledge of CPR and swimming instruction for all persons using the pool. It is intended for use on residential pools only and the manufacturer assumes no responsibility for injuries or consequential property damage while this product is in use on a swimming pool. Proper installation and maintenance are the sole responsibility of the pool owner.



WARNING: To reduce the risk of injury to bathers, or damage to your product:



This product is not a life-saving device. It is an aid to a multi-level protection program, including adult supervision, knowledge of CPR and swimming instruction for your child.



Do not use if unit is damaged in any way.



Use this product only for its intended use as described in this manual



Unit must be submerged in water to operate properly.



Sensor Calibration

While the life expectancy of this alarm system is in excess of five years, the effects of a swimming pool environment may shorten this period. It is recommended that the alarm be recalibrated or refurbished by the manufacturer every 5 years after installation. For questions about installation and warranty, call (732) 730-9880.

Rectangular or oval pools

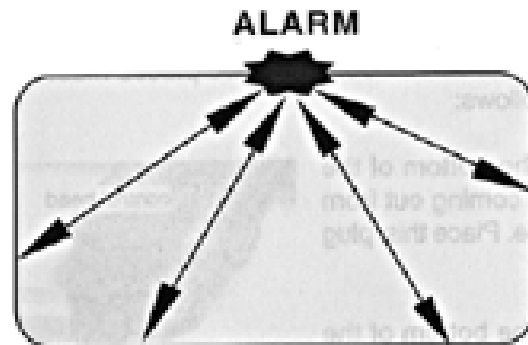

Place alarm in a central location for shortest distance from all parts of the pool

Round pools

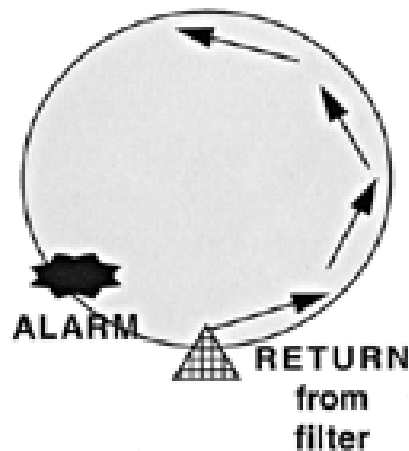

If the water returning from the filter is positioned at 6 o'clock and the flow is counterclockwise, the best location to put the alarm is between 8 o'clock to 9 o'clock position.

On the other hand, if the flow is clockwise, the alarm should be placed between 3 o'clock to 4 o'clock position.

ALL POOLS

Do not point the eyeball of the return towards the center with the alarm at the side. The flow from the return will interfere, so the alarm sensor cannot detect the wave motion properly.

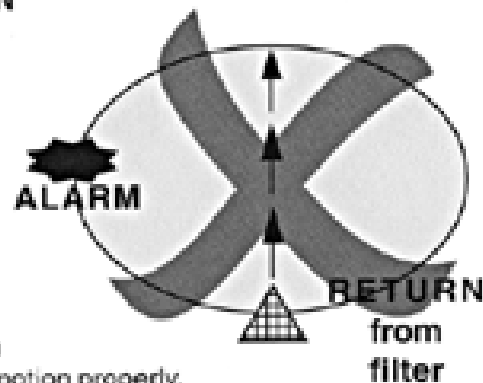

WARNING: Every pool condition varies, test the alarm before use

Pool Side Alarm Transmitter Assembly

The pool side alarm transmitter comes with a control head and a separate sensor tube. Before the unit can be used, the two pieces must be assembled together as follows:

Locate the phone jack at the bottom of the control head, and a plug coming out from one end of the sensor tube. Place this plug into the phone jack.

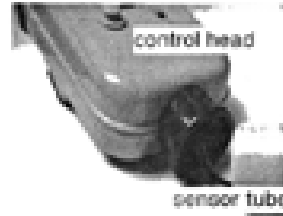

Gently push the tube into the bottom of the control head. The sensor tube end should fit snugly into the bottom of the control head.

Battery Installation

The pool side alarm transmitter is designed to be powered by 6 pcs standard 1.5V AA battery (not included).

After installing batteries, press the **?** button located at the front on the control unit. The alarm will sound either one beep, or 5 consecutive beeps. This will depend whether the unit is turned **ON** or **OFF**.

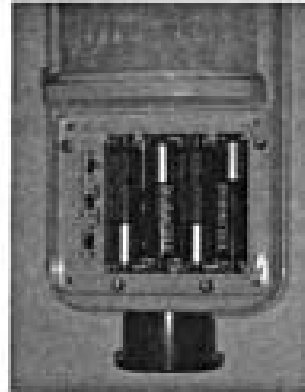

Low Battery Indicator

Transmitter

The unit has a built-in microprocessor which automatically monitors the battery level. When the batteries are running low, it will sound a chirping tone approximately once every 60 seconds. Simply replace the batteries with new ones when this occurs.

When the transmitter detects the batteries are low, it will also send a special RF signal to the receiver.

Receiver

When the batteries of the poolside alarm are running low, the receiver will say **CHECK THE BATTERY** once every 60 seconds. The green and yellow LED will alternate, until the **RESET** button is pressed. Replace the batteries of poolside alarm when this occurs.

Pool Side Alarm Mounting

NOTE: For winterizing in cold climates, keep in mind that you will remove the alarm upon closing. This may influence the location and mounting method you choose.

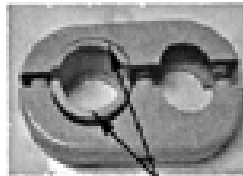

adapters for 1.5 inch ladder



1. Ladder Mounting

Two pairs of **W** shaped plastic clamps are provided to mount the unit onto a standard 1.9 inch round pool ladder. For a 1.5 inch diameter round ladder, use the adaptors as shown.

The unit must be mounted upright and rigidly to the ladder, otherwise it will not function properly.



2. Deck Mounting

A powder coated stainless steel bracket and two sets of **U** shaped plastic clamps are used to mount the unit along the deck of in-ground pools. The metal bracket can either be bolted onto the deck by the two stainless steel screws, or attached with 4 sets of 3M Dual-Lock pads. If your pool has a concrete deck, we suggest you coat the deck with water-proof paint in the area you will be placing the pads. The water-proof paint will prevent calcium migration that will attack the adhesive. Ensure the area is dry and clean before you mount the pads.

Mounting for flat deck



Mounting for sloped deck



Press the bracket down firmly. The adhesive will develop a strong bond under pressure. If the deck has a sloped edge, attach the two square plastic pieces to the end of metal bracket to make it level. It is important to make the bracket level so that the sensor tube can be held vertically.



Clamp the unit onto this metal bracket by the 2 sets of U shaped plastic clamps. Tighten the screws, but do not strip the threads.

Place the unit such that the wide side of the moving sensor is parallel to the side of swimming pool wall.

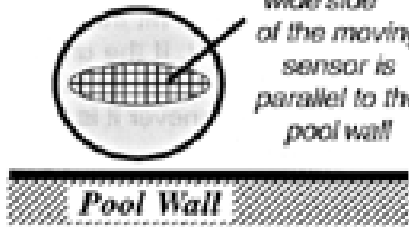

Check the sensor in the water. The sensor is buoyant and should stay upright. If the sensor lies on its side, please contact SMARTPOOL immediately. The sensor must remain in an upright position while it is in the water.

If you have to place the unit near the return, heavy water current may set off the alarm. If this happens, put the deflector cap onto the sensor cage as shown. Place the cap against the water current. Please note that the sensor cage with a deflector cap will reduce the sensitivity of the unit. Check the unit function according to the description in the Sensitivity Adjustment before use.

NOTE: The deflector will reduce sensitivity. Test the alarm unit as described in Sensitivity Adjust section and test again as described in Alarm Unit Function Test section.

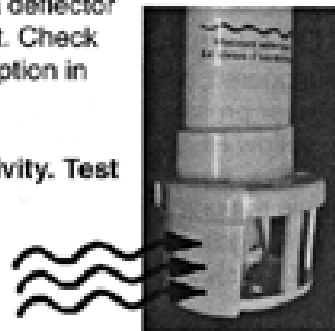

Turn The Unit ON

Press the green ON button and the unit will sound one short beep to indicate it is on. The water motion sensor will begin to function 5 seconds after the unit is turned ON. The alarm siren will sound when the sensor picks up any water motion. Therefore you should wait a few minutes for the water to settle down before turning on the unit.



If the alarm goes off immediately after you hit this green ON button, recheck the mounting of the alarm unit. If the unit is not securely mounted, pushing the control head will cause the alarm to sound off. If the alarm continues to sound off whenever it is turned on, please read the Sensitivity Adjust section.

When the unit is turned ON, it will send out a RF signal to the receiver. The green LED of the receiver lights up.

Turn The Unit OFF

Press and hold both the green ON and the yellow RESET button simultaneously for 3 seconds, until you hear 5 consecutive beeps. The unit is now turned OFF.

NOTE: If the water motion sensor is triggered, alarm will not stop until 3 seconds after pressing both the green ON and the yellow RESET button simultaneously.

When the unit is turned OFF, it will send out a RF signal to the receiver. The yellow LED of the receiver flashes.

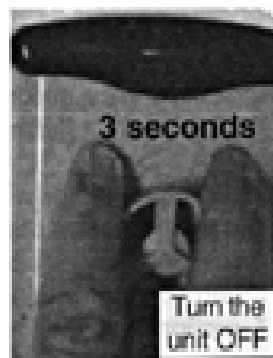

Reset The Unit After Alarm Sounds

Press the yellow RESET button to turn off the siren. This will reset the unit to the ON state automatically. If the water motion sensor is triggered, turn off the unit by pressing both the green ON and the yellow RESET button simultaneously, until the water settles down.



NOTE: If the water motion sensor is triggered, alarm will not stop until 3 seconds after pressing both the green ON and the yellow RESET button simultaneously.

After the unit is turned OFF, the unit can be reset in two different modes:

Instant reset

This allows the unit to response to the water motion within 5 seconds after the following procedures:

- 1) Press the green button
- 2) Then press the yellow button

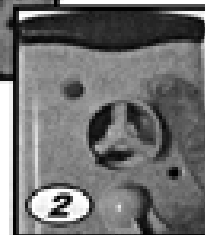
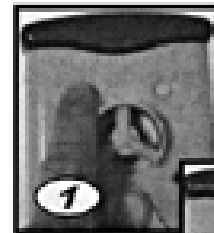

Delay reset

This allows the unit to have 3 minutes delay after pressing the green button. During this 3 minutes, the alarm will not sound even water is not settled and the sensor keep triggering. The unit will reset automatically after 3 minutes.

NOTE: The RF function is active during this 3 minutes delay.

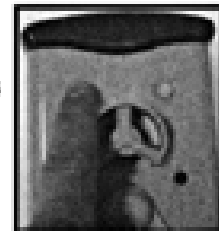

Sensitivity Adjustment

1. Sensor position

The most effective way to adjust the sensitivity is to move the sensor adjust piece located at the bottom of the sensor tube.



Loosen the two screws on the bottom of the sensor.



Move the plastic piece with the pointer pointed to **H** if you want higher sensitivity or to **L** if you want lower sensitivity. The unit is preset at factory to **H**.

If you have to place the unit near the return water flow, snap the cap onto the sensor cage facing the direction of water flow. See Pool Side Alarm Mounting on page 7.

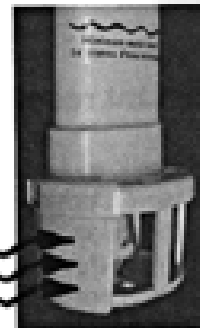

NOTE: The cap will reduce sensitivity. Test the unit as described in Alarm Unit Function Test on page 10 before use.

2. Depth of immersion

The patented design sensor can pick up underwater wave motion caused by an object falling into water. The sensitivity of this sensor is also dependent on the depth of immersion. The unit will be more sensitive if it is placed closer to the water surface.

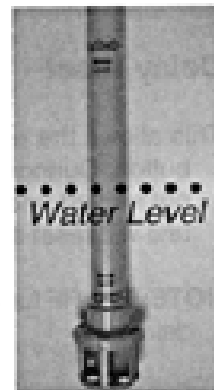

Alarm Unit Function Test

Fill a clean and empty 5 Gal pail 1/3 full with water and drop the pail from a height of a few inches from the surface of water. The wave created should activate the alarm, after allowing ~4 ft. per second to reach the alarm. If this test is unsuccessful, adjust the sensitivity (refer to Sensitivity Adjust section).

Between each weight drop test, you should turn the unit OFF. Then wait until the water settles.

Repeat the same process at all locations of your pool. If the alarm fails to sound, move the alarm unit to another position and try again. If you find a dead zone in your pool, this may be an indication that your pool needs a second alarm unit.

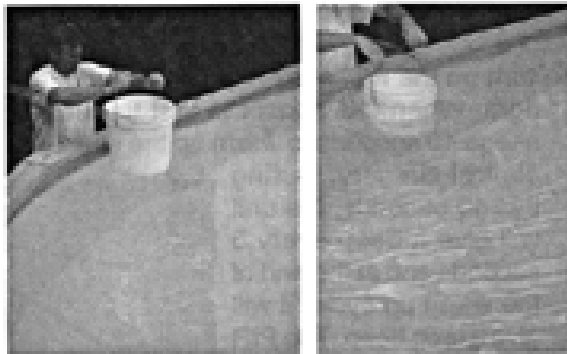

Do not use the unit until the test results are satisfactory. Test the alarm at least monthly.

IMPORTANT NOTES:

Allow about 4 feet per second for the underwater wave to reach the alarm.

If the underwater wave motion is unsettled, the alarm siren will sound when you release the button. In this case, turn OFF the unit until the water settles down, and then turn the unit ON again.

Pools larger than 18 feet by 36 feet, L-shaped, or some other free form pools, may require more than one pool side alarm transmitter for effective monitoring.

The pool side alarm unit should be able to detect an object that weighs over 15 lbs.

PIR (Passive Infra Red) Sensor

PIR sensor is used to detect any temperature difference caused by human body movement against a cold background.

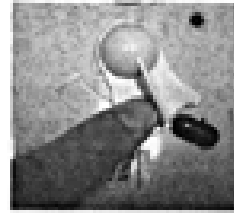

The pool side alarm unit has a PIR sensor designed to monitor the pool entrance or other area an intruder might pass before they enter the pool.



To turn on the PIR sensor, turn the knob to the right. When this sensor is first turned on, it needs 40 seconds to warm up the sensor and control circuitry. During this 40 seconds, the unit will give a beep every 5 seconds and at the end of the warm up cycle, it will give a long beep. The PIR sensor starts to function.

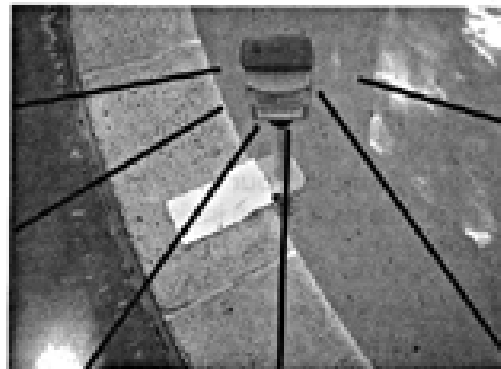

To turn the PIR sensor off, push the blue button to the right and then turn the knob to the left.

The PIR sensor covers a range of 150 degrees and up to 24 feet. Because PIR sensor detects temperature difference, the range of detection may subject to ambient temperature as well as the surrounding environment.

Rotate the head so that the sensor points to the pool entrance area or the area you feel be most effective in sensing someone entering the pool area.

PIR Detection

When this PIR sensor detects any object moving around the pool within its range, it will send a wireless signal to the receiver and make a pulsating beep for up to 30 seconds. After this 30 seconds, the unit will reset automatically to stand by state.

When the receiver gets this signal, it will say **CHECK THE POOL** 3 times and then reset automatically.

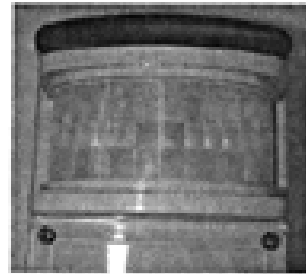

PIR Sensitivity Adjustment

To access the PIR sensor sensitivity adjust switch, open the battery door. You can find the PIR Sensitivity switch located on the left hand side of the battery compartment. Slide to **H** if you want higher sensitivity. Slide to **L** if the unit gives frequent false signal. The factory default setting is at **H**.

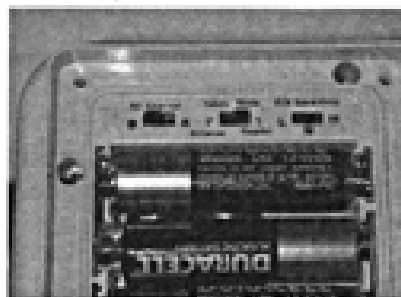

Motion around the pool, PIR sensor

Reset The PIR

When this PIR sensor detects any object moving around the pool within its range, it will make a pulsating beep for up to 30 seconds and then reset automatically. To reset the unit manually, press the yellow instant reset key. When reset, the unit will be temporarily disabled for 40 seconds, allowing you enough time to walk away from its detection range. During this 40 seconds temporarily disabled period, the unit will give a beep every 5 seconds and at the end of the warm up cycle, it will give a long beep. The PIR sensor starts to function.

Delay reset

Delay reset can only be obtained after the water disturbance sensor is triggered, turned OFF and then press the green button once without pressing the yellow instant reset button (refer to page 9). This allows the unit to have 3 minutes delay. During this 3 minutes, the alarm will not sound even the PIR sensor is triggered. The unit will reset automatically after 3 minutes.

NOTE: The RF function is active during this 3 minutes delay.

To turn the PIR sensor off, push the blue button to the right and then turn the knob to the left.



Safty Mode --- Regular

To access the PIR sensor sensitivity adjust switch, open the battery door. You can find the PIR Sensilvity switch located on the left hand side of the battery compartment. Slide to the right to set to regular safety mode.

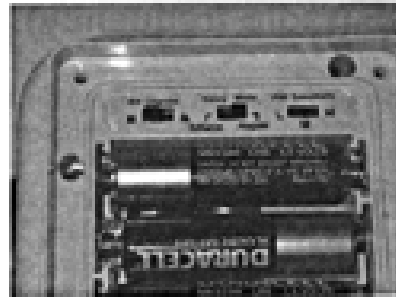

Alarm set at this mode allows the PIR sensor and the water motion sensor operates seperately. You can turn either one of the sensor ON or OFF, or to turn both ON or OFF.

Safty Mode --- Enchance

Alarm set at this mode allows a multi-level protection to your pool. If the PIR sensor is turned ON and it detects any motion around the pool area within its detection range, it will check the water motion sensor if it is turned ON or not. If the water motion sensor is turned OFF at that moment, the unit will wake up the microprocessor to turn ON the water motion sensor. The water motion sensor will stay ON until one minute after the intruder left the pool area.

The unit will make a pulsating beep as long as the intruder stays and moves around the pool area within its detection range. At the same time, the unit will send a wireless signal to the receiver.

When the receiver gets this signal, it will keep saying ***GHECK THE POOL*** until the intruder left the pool area.

Remark:

If you use your pool cleaner, it is recommended you **NOT** select this enhanced safety mode to avoid false water motion sensor trigger. Use regular safety mode instead.

Motion around the pool, PIR sensor

RF (radio frequency) Signal Link Testing

This unit provides a convenient RF link testing, to ensure good RF transmission without setting off the alarm.

First press the yellow button to reset the unit. Hit the **?** button and hold for a couple of seconds. The unit will first sound one beep or five consecutive beeps. This will depend on whether the unit is set to ON or OFF. Continue to hold this **?** button for three seconds until you hear three consecutive beeps. The unit will send out a RF alarm signal to the receiver inside the house without setting itself off.

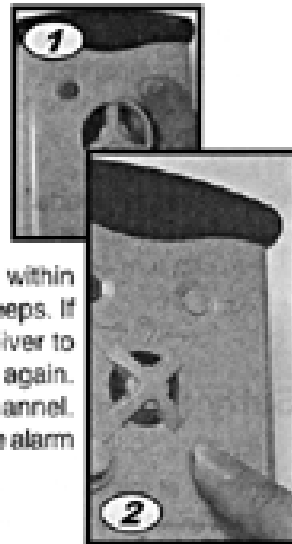

The receiver inside the house should sound within ten seconds after the three consecutive beeps. If the receiver does not ring, move the receiver to another location and check the installation again. Ensure all devices are set to the same channel. (Refer to channel A/B select of both pool side alarm transmitter and receiver).

IMPORTANT NOTES:

Remember to check the RF link periodically to ensure good RF transmission. If the RF signal is weak, replace the battery in the pool side alarm with a new one.

RF signal can be transmitted through a solid wall. However, it is possible that this may weaken the RF signal. To avoid this, it is important to place the receiver in a straight line of sight to the transmitter whenever possible.

Battery level affects RF signal strength. A weak battery in the pool side alarm transmitter will give a weak RF signal out.

Transmitter Channel A/B Select

The pool side alarm RF (radio frequency) signal can be transmitted from the transmitter to the receiver inside the house by two different channels (A or B). All units are preset at channel A in the factory. However, if your alarm system interferes with your neighbor's alarm system, you may have to change your alarm unit to channel B.

The pool side alarm unit has a built-in channel select switch. This is located inside the battery compartment. Follow these instructions to change the channel.

1. Open the battery door. You can see an A/B slide switch located at the left hand side of the battery compartment.
2. Use a screw driver to push the switch handle from A to B. Make sure to do the same channel adjustment on **ALL** your alarm devices, including the receiver.



Remote Receiver

Place the remote receiver inside your house, but close to the pool side alarm unit and at a straight line of sight. **DO NOT** place the unit near large metal objects or large motors, such as a refrigerator, or washing machine. This will adversely affect the RF reception.

Plug in the A/C adapter and the yellow LED on the left flashes, indicating it is ready to receive signals.

Hit the RESET button located between the two LEDs, to reset the receiver. Each reset will disable the receiver for 10 seconds, allowing you enough time to go to the pool side alarm transmitter to reset it, or turn it off. During this 10 second timeframe, the yellow LED on the left will flash quickly. If you do not reset the receiver, it will reset automatically in four minutes.

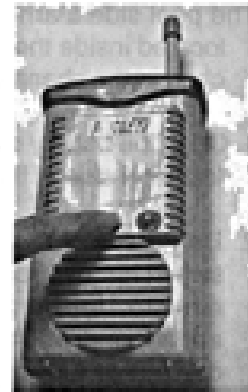

LED Indication

The receiver gives 4 different LED indications:

- (1)** Yellow LED flashes once per second: This happens when the the A/ C adapter is first plugged in. It may also indicates the poolside alarm is turned OFF.
- (2)** Green LED stays on: This indicates the alarm outside is turned ON.
- (3)** Green and Yellow flashes alternatively at 1 second cycle: This indicates batteries of the alarm outside are running low. Change the batteries with new ones and reset this receiver. It may also indicates the receiver has received a signal from the PIR sensor.
- (4)** Green and Yellow flashes quickly: This indicates the receiver had received an alarm signal from the water motion sensor.

Receiver Channel A/B Select

The remote receiver has a built in channel select switch, located inside the receiver box. Loosen the four screws and remove the battery door. You can find a slide switch at the corner marked **A** and **B**. Push the switch handle from position **A** to position **B**. Make sure you do the same channel adjust on all your devices, including the pool side alarm transmitter. Check the RF link periodically to ensure good RF transmission.

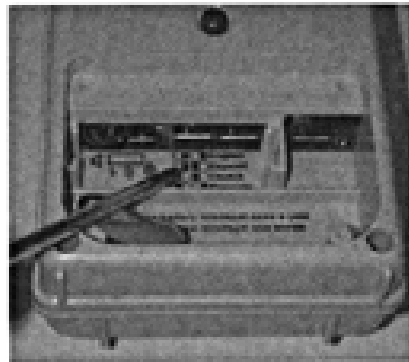

Language Select

You can select either one of the following 4 languages: English, Spanish, German and French.

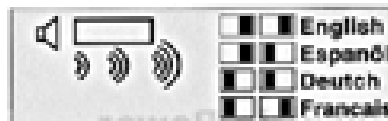

The language selection switches are located inside the receiver box. Slide the switches as shown to select the language.

Speaker Volume

You can adjust the loudness of the receiver speaker. The volume switch is located inside the receiver box.

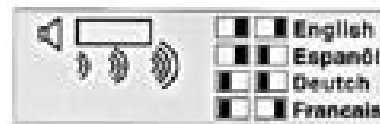
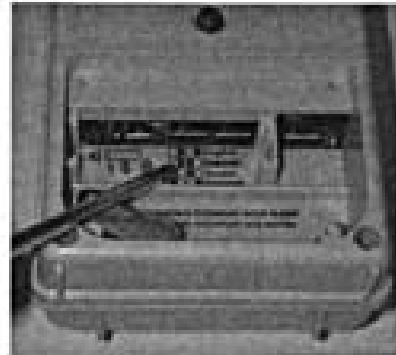

Back Up Power

The receiver unit is designed to use a regular alkaline 9V battery as back up power source. To install this back up battery, remove the 4 screws and open the battery door. Change the battery minimum once a year.

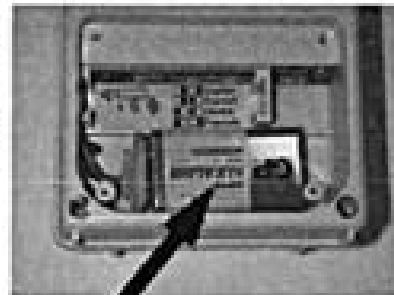

How To Connect To Your Home Security System

NOTE: If you are not familiar with security systems, contact a professional for connection.

The remote receiver has a three junction terminal block, so that you can connect it to your home security system or other third party safety device. When the receiver receives a RF (radio frequency) alarm signal, it will activate the terminal block in 3 seconds. Resetting the receiver within 3 seconds ensures that you will not activate your home security system.

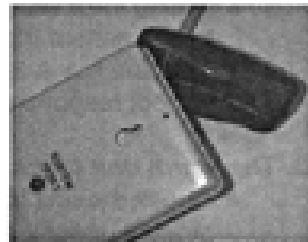

Loosen the screw at the top and remove the blue cap. Remove the battery door and loosen the two screws. Open up the box and you can find a 3 junctions terminal block near the A/C adapter power jack.

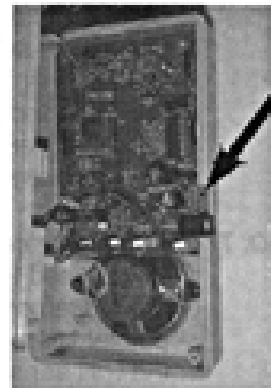

The terminal block signal switching is controlled by microprocessor. For current switching, it is recommended to connect a K-1 type relay (not included) to the terminal block as shown.

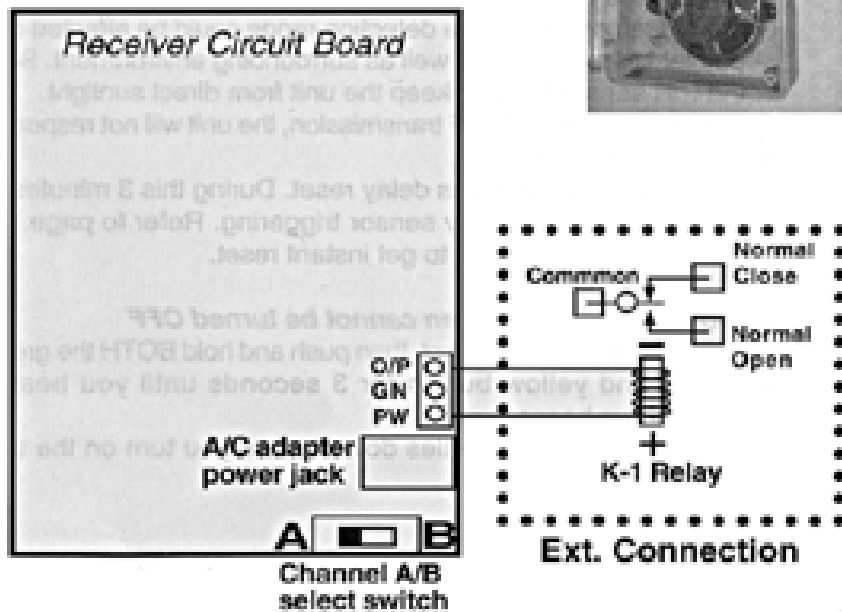

Trouble Shooting

Q. Alarm unit cannot detect underwater wave signal

- ★ Check the unit by hitting the **?** button. If the unit does not give any beep, replace the 9V battery with a new one.
- ★ Check the phone jack connection between the sensor tube and the alarm unit control head. Make sure it is connected properly.
- ★ Check the sensitivity setting on the bottom of the underwater sensor and the depth of the sensor into the water.
- ★ During the 5 seconds RF transmission, the unit will not response to any sensor triggering.
- ★ The unit has a 3 minutes delay reset. During this 3 minutes, it will not response to any sensor triggering. Refer to page 9.

Q. The alarm unit gives frequent false alarms

- ★ Check the unit installation. Make sure it is mounted rigidly and straight upright. If the unit can be moved sidewise under strong wind, it indicates the unit is not mounted rigidly.
- ★ Check the sensitivity setting. The sensitivity may be set too high.
- ★ The sensor can detect any water disturbance including the flow from the filter pump. Place the alarm unit away from the return, or put a deflector cap on the sensor cage.

Q. The PIR sensor cannot detect object motion

- ★ PIR is used to detect body temperature against cooler background temperature. The detection range could be affected by ambient temperature as well as surrounding environment. Set the PIR sensitivity to H, keep the unit from direct sunlight. During the 5 seconds RF transmission, the unit will not response
- ★ to any sensor triggering.
The unit has a 3 minutes delay reset. During this 3 minutes, it
- ★ will not response to any sensor triggering. Refer to page 14. Press the yellow button to get instant reset.

Q. The poolside alarm unit siren cannot be turned OFF

- Press the yellow button first, then push and hold BOTH the green
- ★ button and yellow button for 3 seconds until you hear 5 consecutive beeps.
- Wait until the water settles down before you turn on the unit
- ★ again.

Q. The receiver cannot receive RF alarm signal.

- ★ When the blue RESET button on the front is pressed, the unit is disabled for 10 seconds. During this 10 seconds, it will not receive any RF signal. This allows you enough time to go to the poolside to turn off or reset the poolside alarm.
- ★ Check the channel A or B select. Make sure every unit is set at the same channel.
- ★ Place the receiver closer to the transmitter and at a straight line of sight. The RF signal sending out from the transmitter is directional. Placing the receiver at another location may give a better reception. Avoid any big metal object such as refrigerator, oven or washing machine etc. between them.
- ★ The transmitter has an antenna inside the control head. Rotating the control head may affect the RF signal sending out, similar to your TV antenna. However, make sure the wide side of the underwater sensor remains parallel to the pool wall. Holding the sensor tube and twisting the control head can do this. If you need a bigger adjustment, it is recommended that you disconnect the control head.

Q. The receiver alarm siren cannot be turned OFF

- ★ Press the SYSTEM RESET switch located on the back of the unit.

Q. Pool alarm sounds off when I use my pool cleaner

- ★ Your pool cleaner can create the same type of water disturbance as that created by a child falling into water. Therefore the pool alarm may be set off if you activate your automatic pool cleaner while the alarm is ON.

Q. The receiver does not sound alarm immediately when the poolside alarm goes off

- ★ Weak RF signal is more susceptible to any interference. Replace the 9V battery with a new one.

Winterizing

You must remove your alarm when closing your pool for the winter. Simply reverse the installation process and store the unit in a warm, dry area.

**For installation questions,
call 877-799-7665 (toll free)
weekdays 1- 4 pm EST.**

SmartPool Inc.
575 Prospect Street
Lakewood
NJ 08701

Printed in China March 2001