

MODEL CE - COMBO POOL ENTRY SYSTEM with GATE



IMPORTANT INSTRUCTIONS: Read all instructions carefully & completely to become familiar with all parts, assembly, safety and proper use of this product. Review with all using entry & pool. Failure to follow these instructions may result in serious personal injury. **SWIM RESPONSIBLY & SAFELY!**

TOOLS REQUIRED: 7/16" socket, nut driver or wrench, measuring tape, Phillips (star) screwdriver, 1/4" & 1/8" drill bits & drill, pencil or marker & level. **PAD LOCK REQUIRED.**

SAFETY INSTRUCTIONS & PROPER USE - ASSEMBLY & INSTALLATION

- This pool entry system has a 300 lb load capacity (one person) when properly assembled & installed
- Your above ground pool has shallow water - absolutely **NO DIVING** or **NO JUMPING** into the pool
- This product conforms to the latest revisions of the ANSI/APSP recommended standards for above ground / on ground swimming pool ladders / entry systems. **DO NOT** use for other purpose
- This entry is designed for use with flat bottom pools. Use of a ladder / step pad is recommended
- For entry & exit of the pool, face steps or ladder at all times. Use handrails to assist climbing
- This system is designed for use by one person only at all times
- This system is designed with a protecting gate system - **NEVER** use system without gate
- When pool is not in use, make certain gate is securely closed, latched & **LOCKED** to restrict access
- Locate entry system on a solid base and free from high traffic areas around the pool
- This entry system **MUST** be secured to top rail of pool for greater stability and safety
- Keep top platform and treads free from obstructions to avoid possible injury. Do not secure any items to the entry system. Such objects (e.g. thermometers, play toys, ropes) may create a potential for tripping or entrapment
- **NEVER ALLOW CHILDREN TO SWIM UNATTENDED** - Nothing replaces parental supervision
- Assemble and install this pool entry system as per the manufacturer's instructions. Do not deviate from these instructions

IDENTIFY PARTS



Stainless Pins



3/4" Bolt



1" Bolt



3" Bolt



Handrail
Fillers



Gate Hinges & Stop



Tread-Riser - 3 pcs



Top Tread - 1 pc
Bottom Riser - 1 pc



Latch
Shield



Top Platform - 1 pc



Gate - 1 pc



Ladder - 1 pc



Upper
Handrails
2-Right
& 2-Left
← Lower
Handrails
1 - Left
&
1 - Right



Stringers - 1 Left & 1 Right

Step 1: FIT TREADS & RISERS INTO STRINGERS



1.1

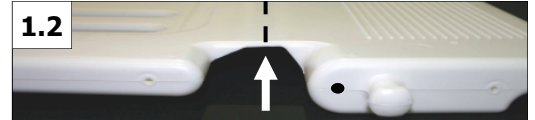

1.2

Each of the full tread risers is designed and manufactured to fold down the "center line" (indicated above with arrows). The plastic used in the manufacture of these parts is flexible, however, temperature is an important factor on how easily they will fold. The colder the material the harder it will be to fold the parts. **HINT:** if you heat the entire "center line" of the tread risers they will fold easier. Using hot water, a heat gun or hair dryer or even laying the parts in the direct sunlight will soften the plastic and allow them to fold easily. Make certain not to overheat the plastic - it can permanently mark or damage the parts



1.3



1.4



1.5



1.6

The fit and positioning of the treads and risers into the stringers is very specific. Each of the stringers has indentations with holes which the ends of the treads and risers fit and lock into. The treads and risers have button lock knobs on the ends which fit through the holes of the stringers and lock each part in place. Lay the right (R) stringer on a flat surface with the indentations facing up (Detail 1.3 & 1.4). The proper positioning of all treads and risers is outlined in Detail 1.5 & 1.6. Review this layout for correct positioning of all parts

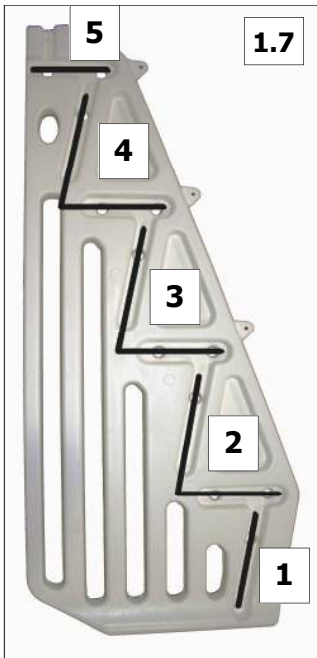

FIT HALF TREAD & RISER AND SECURE

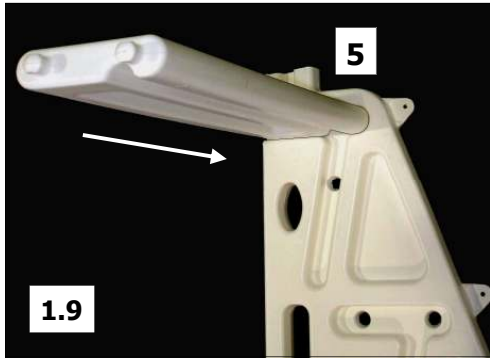
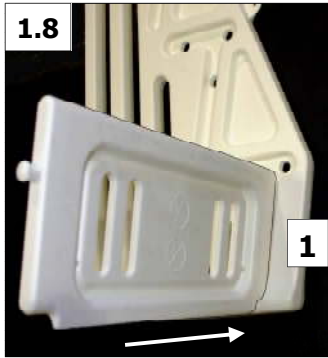

Identify the half bottom riser part. With the warning signs facing out, away from the steps, fit the bottom riser into the indentation of the stringer at **POSITION 1** (see Detail 1.7 & 1.8). Press the bottom riser into the stringer until the button lock knob on the end protrudes through the hole and locks the part in place (see Detail 1.10). Identify the half top tread part. With the anti-skid surface facing up, fit the top tread into the indentation of the stringer at **POSITION 5** (see Detail 1.7 & 1.9). Press the top tread into the stringer until the button lock tabs on the end protrude through the holes and locks the part in place (see Detail 1.10)

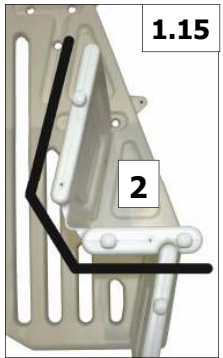
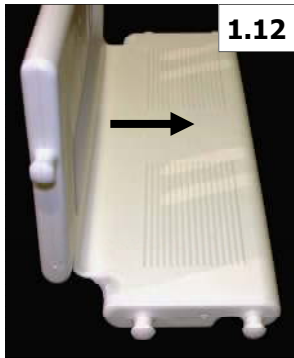
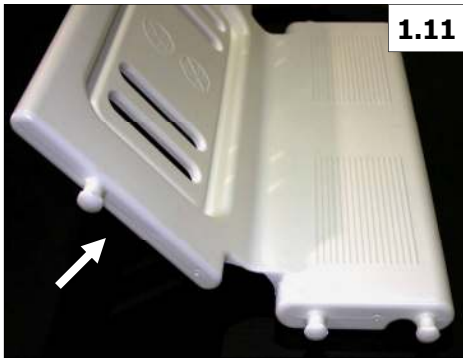

Identify one of the tread-riser parts and lay it on a flat surface. Holding the tread portion in place, fold the riser portion over (see Details 1.11 - 1.13). Make certain to fold warning signs on riser portion toward anti-skid surface of tread portion. You can over fold until portions touch as they will want to go back to their original position once you let go. Take the folded tread-riser and fit it into the indentations of the stringer at **POSITION 2** (see Detail 1.7, 1.14 & 1.15). **Note:** the tread portion with two button lock knobs will fit into the horizontal indentation in the stringer just above the half bottom riser already installed. The riser portion will fit into the next indentation above it. Press the tread-riser into the stringer until the button lock knobs on the ends protrude through the holes and lock the part in place (see Detail 1.10). Similarly, with another tread-riser, fold the part and insert it into indentations at **POSITION 3**. Take the last tread-riser and complete the assembly of the treads and risers at **POSITION 4**. Make certain all button lock knobs secure parts in place (Detail 1.10)



Step 2: FIT OPPOSITE STEP STRINGER & SECURE

With all treads & risers securely installed into the right stringer, position a left stringer (Detail 2.1 & 2.2). Similarly, the indentations in the left stringer fit over the ends of the treads and risers; align the button lock knobs with the holes in the stringer & press the stringer down locking all parts together. Make certain all knobs are locked through stringer holes (see Detail 2.3). Stand completed step assembly upright.



FOLLOW ALL ASSEMBLY INSTRUCTIONS FOR A SAFE AND STABLE POOL STEP ENTRY SYSTEM. USE OF A STEP PAD IS HIGHLY RECOMMENDED



Identify the upper RIGHT (R) & LEFT (L) handrails (small stamp in part - as shown in 3.1). **NOTE:** both left & right handrails have a small bolt flange molded on the side (Detail 3.2). These bolt flanges are used for the exterior portion with the gate (step portion), to join the upper handrails with the lower handrails. The in-pool handrails have flanges but they are not used. Fit handrail pairs together as shown in 3.3, 3.4 & 3.5. Align bolt holes and secure using 1" bolts, washers and nuts. Tighten all hardware. Repeat for both sets of upper handrails. Make certain each set of handrails is secured together correctly (left with right - both pairs / sets)

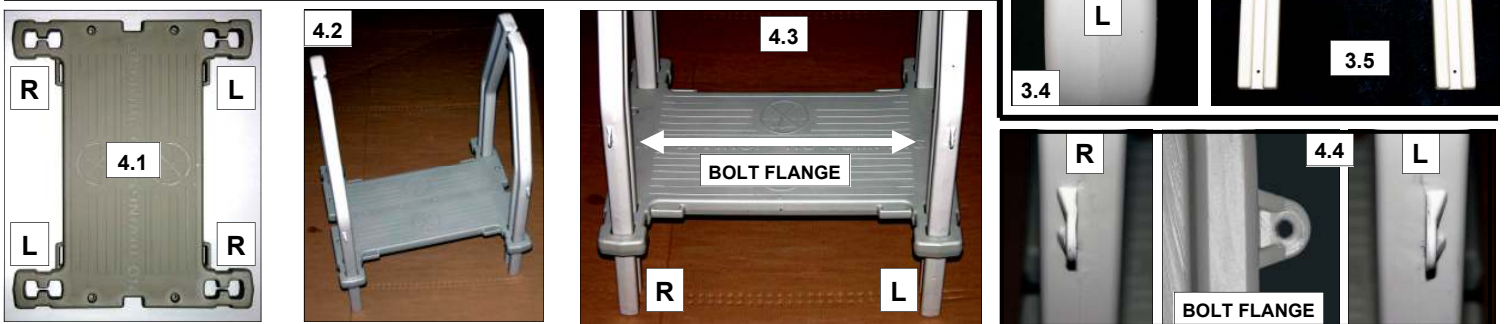

Identify top platform, and with anti-skid surface facing up, fit handrail pairs through platform as shown in 4.1 - 4.3. Repeat for both sets of upper handrail pairs on both sides of top platform. **NOTE:** the left and right handrails with the bolt flanges **MUST** be on the same side of the top platform (Detail 4.3 - 4.5) as they are used for the step portion of the entry (to connect the lower handrails). Fit assembled handrail pairs & platform into top openings of assembled step and ladder section as shown in Detail 4.5. Make certain the correct handrail fits into the appropriate hole in the step assembly and ladder. Note that the ladder has a slight angle when fitting the handrails into the open sockets (see Detail 4.6). The ladder section will angle out, away from step at bottom. This will make your ladder section inside the pool easier to climb. The ends of the handrails fit tightly into the openings at the top of each stringer and the ladder section. Make certain to push them all the way down into the opening until they bottom out. **FOR THE STEP PORTION ONLY**, align bolt holes & secure using 3/4" bolt, washers on both sides & nut. Repeat for both handrails fitting into the step. Tighten hardware. **DO NOT FASTEN HANDRAILS & LADDER SECTION UNTIL STEP 7.**

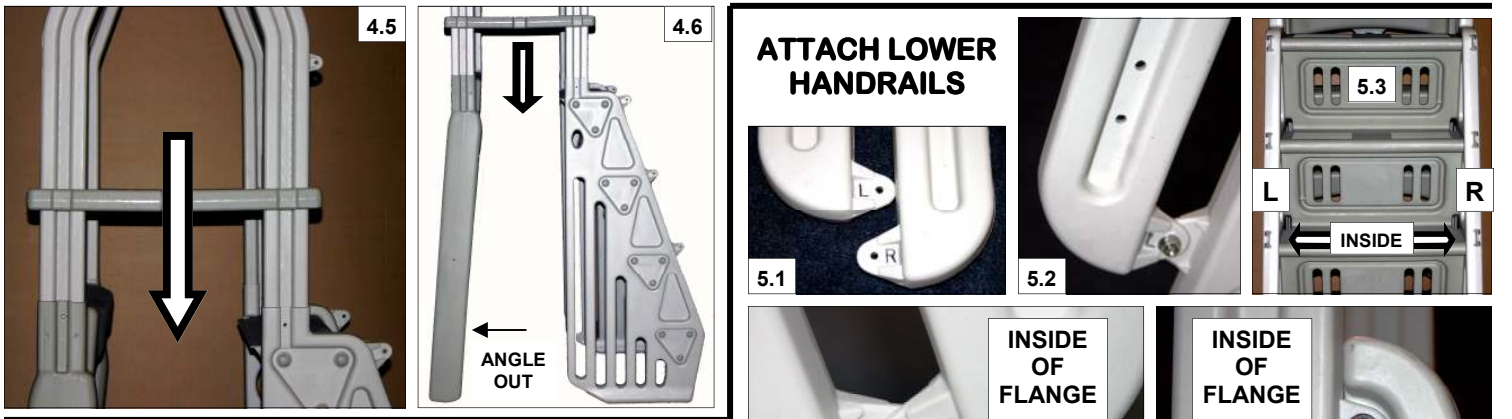

Identify the RIGHT (R) & LEFT (L) lower handrails (Detail 5.1). **NOTE:** the left handrail has holes drilled in it to accept the gate hardware (see 5.2). Facing the step section, the lower left handrail attaches on the left & lower right handrail attaches on the right (5.3). Make certain the handrails are inside the three bolt flanges on the stringers and inside the bolt flanges on the upper handrails (see 5.3 - 5.5). When on the inside of the tab on upper handrail, the upper & lower handrails will be perfectly in line (see 5.6). Align holes and fasten using a 3/4" bolt, washer and nut at all four locations. Tighten all hardware.



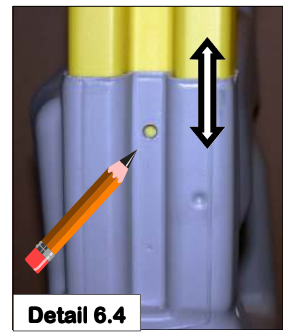
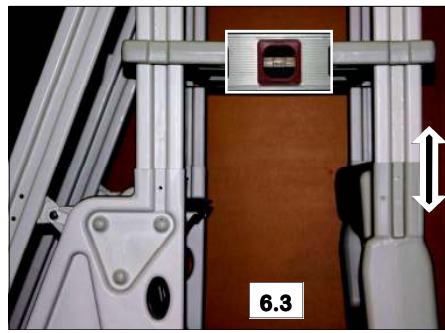
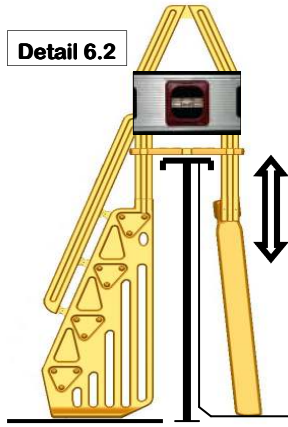
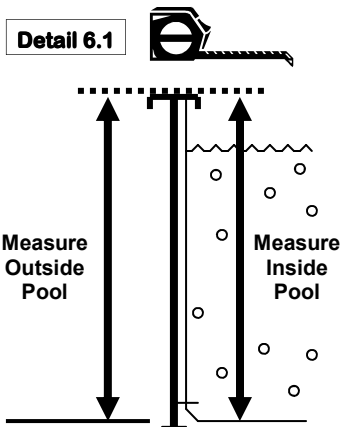

Remove entry from pool. With ladder section set to proper height adjustment, drill a 1/4" hole through both handrails at the hole locations in the side of the ladder section, at your marks (Detail 7.1). The inside face of the handrails have an open cavity to fit handrail fillers (Detail 7.2 & 7.3). Fit & slide handrail fillers down (Detail 7.4). The filler will catch over ladder section and align with holes (Detail 7.5). Secure in place using a 2" bolt & washer, for both handrails - tighten hardware.

Measure the height to the top rail of the pool, both inside & outside the pool (Detail 6.1). If the measurements are different you will need to adjust the entry system. Adjustment in height is done on the in-pool ladder section. With the upper handrails in the ladder section, move the in-pool ladder section up or down to achieve proper measurement - **IMPORTANT** that the top platform of the entry system remain level for safe entry/exit of the pool (Detail 6.2 - 6.3). If required, the handrails can be cut shorter. It is wise to place ladder over top rail & into pool to test for proper height adjustment. Make final adjustments (keeping platform level) & mark both handrails (6.4).

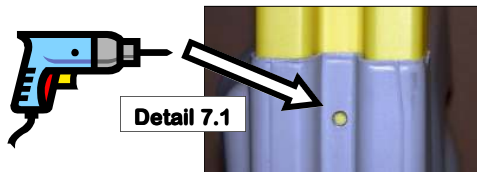

Detail 7.2

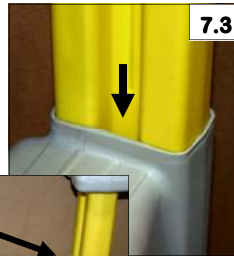

DOUBLE CHECK ALL MEASUREMENTS BEFORE DRILLING HANDRAILS



Place entry over pool wall at desired location. Note: it is suggested to choose a low traffic area for safety. With entry system in place (Detail 8.1) slide top platform down towards top rail of pool. Pull entry out, away from the pool so the in-pool portion is tight to the top rail (Detail 8.1 & 8.2), reducing the space between the in-pool ladder and the pool wall. This minimizes space so children cannot swim through or around ladder (potentially dangerous). With top platform approximately 1" - 2" above top rail of pool, level platform & mark all handrails where they meet the bottom of the platform (Detail 8.2). Important the top platform is level for safe entry / exit of pool.

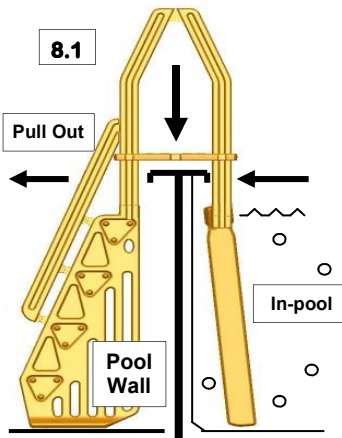

ADJUST & MARK FOR TOP PLATFORM

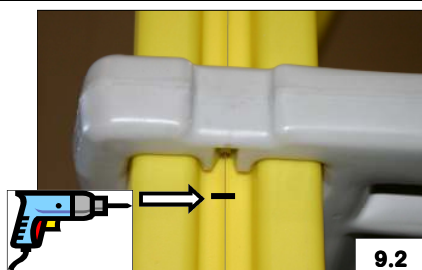
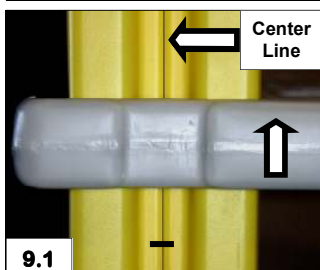
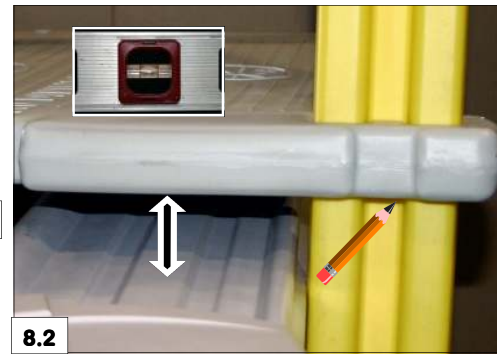

SECURE PLATFORM



Remove entry from pool. Raise top platform to reveal your marks on handrails (9.1). Each handrail has a center line indented in plastic - this is your guide for drilling the center of the handrail. Drill a 1/4" hole at each mark, through the handrail (9.2). Insert a stainless pin into each hole drilled, protruding equally on both sides of handrail (9.3). The top platform has locking channels at each handrail position to snap over pins & lock top platform in place securely. Push top platform down firmly, snapping & locking it over the stainless pins (9.4). Repeat for all four corners & handrails making certain all are locked into position

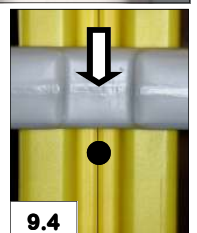

SECURE ENTRY SYSTEM TO POOL

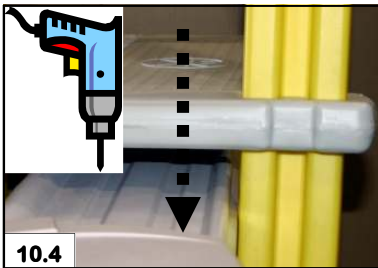
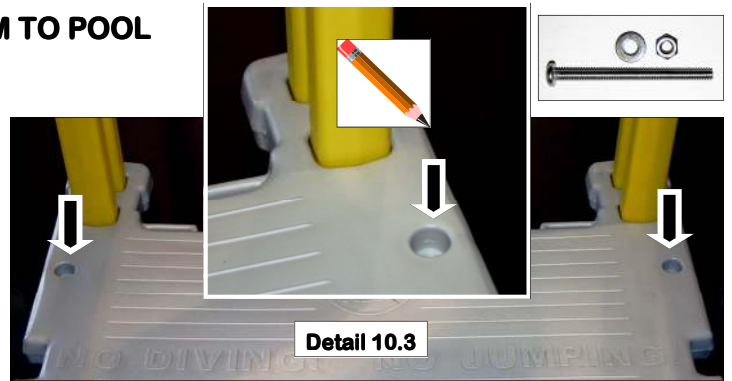
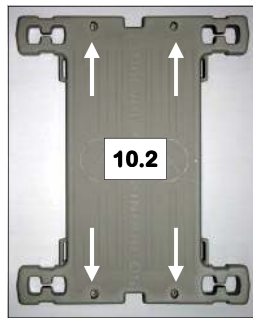
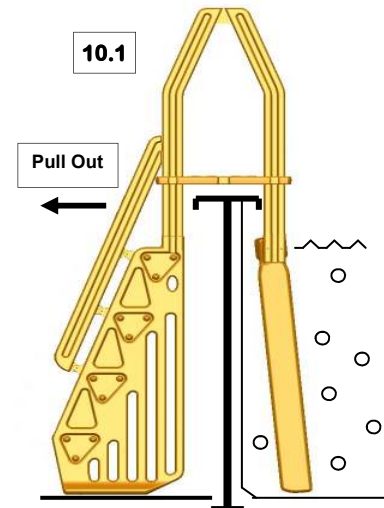

Position entry in pool at desired location (10.1). Pull entry system out, away from pool so the in-pool portion is tight to the top rail (similar to Step 8). Using two of the possible four bolt holes in top platform (10.2), mark two hole locations of top platform onto top rail of pool. Choose the two that best suit your entry positioning & top rail width (10.3). Slide entry system out of the way and, using caution, drill top rail of pool with 1/4" drill bit at marks (10.4). Keep drill shavings out of pool so they do not damage pool liner. Reposition entry & secure in place with 3" bolts, washers & nuts. Tighten to snug so entry system remains securely in place and is safe and stable to climb. Review safety instructions and proper use (from front page of this instruction) with all family members before using entry and pool. Entry system must be removed from pool when winterizing. Drain all water & store in safe place. **REMEMBER - NOTHING REPLACES PARENTAL SUPERVISION.**



MOST IMPORTANT - NEVER USE THIS ENTRY BEFORE FIRST ATTACHING SELF CLOSING, SELF-LATCHING & LOCKABLE GATE. SEE GATE INSTRUCTION PACKAGED WITH THIS ENTRY SYSTEM. FOLLOW ALL INSTRUCTIONS CLOSELY. WHEN POOL IS NOT IN USE, CLOSE GATE AND LOCK SECURELY TO PREVENT UNWANTED ENTRY AND TO KEEP CHILDREN SAFE. NEVER LEAVE CHILDREN UNATTENDED AROUND POOL. SWIM SAFELY!

BE CAREFUL USING TOOLS AROUND WATER

ADD A LIGHT TO YOUR ENTRY SYSTEM!

Optional
12 VOLT
IN-POOL LIGHT
(Model OPT12V)
Sold separately

Ask your dealer
for details

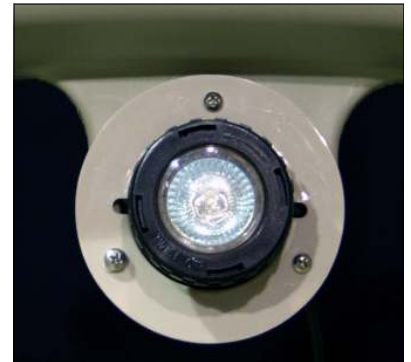

**NEED REPLACEMENT PARTS
VISIT**

www.vinylworkscanada.com

PLEASE REMEMBER
SWIM SAFELY

Hardware Measurement Guide

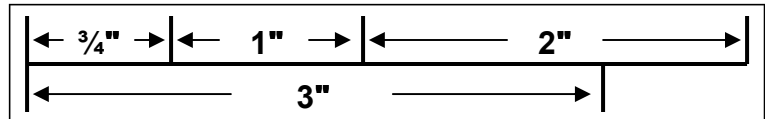

**FOR COMPLETE WARRANTY INFORMATION & REGISTRATION PLEASE VISIT OUR WEBSITE
ALL REPLACEMENT PARTS AVAILABLE ONLINE AT www.vinylworkscanada.com**

VINYL WORKS CANADA - 5 YEAR WARRANTY - PRODUCT REGISTRATION

Register online at www.vinylworkscanada.com or return completed warranty registration to:
Vinyl Works Canada - PO Box 96, Port Colborne, Ontario, Canada L3K5V7
(If mailing from USA international postage is required)

Owner's name: _____ Purchase date: _____ (yy/mm/dd)

Address: _____ Phone #: _____

Pool make: _____ Pool size: _____ Pool height: _____ Retailer: _____

Retailer's address: _____

Product purchased (+VWC model #): _____ Product Color: _____



MODEL GP - GATE PACKAGE for Models AF - CE - GE - G2D Pool Entry Systems & Decks

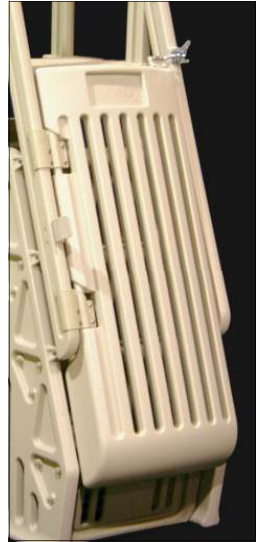

IMPORTANT INSTRUCTIONS: Read all instructions carefully & completely to become familiar with parts, assembly, safety and proper use of this product. Failure to follow these instructions may result in serious personal injury. **SWIM RESPONSIBLY & SAFELY!**

TOOLS REQUIRED: 7/16" socket - nut driver, wrench or pliers, Phillips (star) screwdriver, pencil, 1/8" drill bit & drill + a pad lock for security when the pool is not in use

SAFETY INSTRUCTIONS & PROPER USE - ASSEMBLY & INSTALLATION

- These pool entry systems have a 300 lb load capacity - one person - when properly installed
- These entry systems are designed & intended for use with an above ground pool only (flat bottom)
- Your above ground pool has shallow water - absolutely **NO DIVING** or **NO JUMPING** into the pool
- This product conform to the latest revisions of the ANSI/APSP recommended standards for above ground/on ground swimming pool ladders
- For entry & exit of the pool, when climbing, face steps at all times. Use handrails for safe climbing
- These systems are designed for use by one person at all times
- These entry systems are designed with a protecting gate system - **NEVER** use system without gate attached & fully functional. When pool is not in use, make certain gate is securely closed, latched & locked to prevent unwanted entry
- Locate entry system on a solid base and free from high traffic areas around the pool
- **VERY IMPORTANT** - Secure entry system to top rail of pool for greater stability and safety
- Keep top platform and treads free from obstructions to avoid possible injury. Do not secure any items to the entry systems. Such objects (e.g. thermometers, play toys, ropes) may create a potential for tripping or entrapment
- **NEVER ALLOW CHILDREN TO SWIM UNATTENDED** - Nothing replaces parental supervision
- Install this gate for pool entry system as per the manufacturer's instructions. Do not deviate from these instructions

IDENTIFY PARTS



Outer Hinge
(2 pcs)
(large)



Inner Hinge
(2 pcs)
(small)



Gate - 1 pc

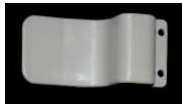

Gate Stop - 1 pc



Latch Shield - 1 pc

The gate & gate components are packaged different for different units - make certain you have all appropriate cartons and parts to complete your chosen pool entry system or deck assembly & installation (Model AF - CE or G2D used with SD & FD decks). Familiarize yourself with all parts and read instructions before starting assembly & installation. If you notice any parts damaged or missing please contact our customer service department for assistance @ 877-VINYL WK.

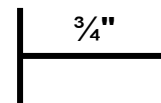

Measurement Guide



1/4" Round



3/16" Round

POSITION HINGES & GATE STOP

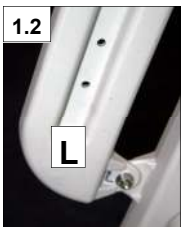

1.2



1.3

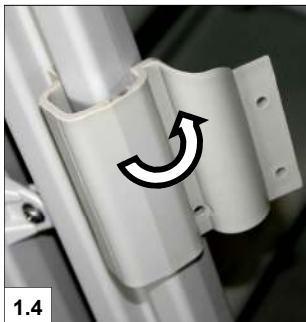

1.4



1.5

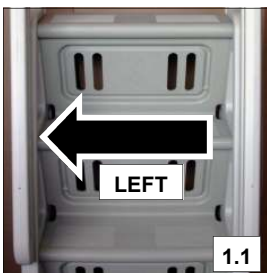

1.1

The LEFT lower handrail on the exterior portion of the entry has holes to accept the hinges & gate stop (see 1.1 & 1.2). Begin by securing the gate stop in place. Fit the stop on the outside face of the handrail over the center two holes - it is form fitting (see 1.3). Secure using two 1/4 x 3/4" bolts, washers on inside & nuts. Tighten hardware. Fit the outer hinges in place around handrail. Likewise, they are form fitting and will snap around handrail (see 1.4). The inner hinge fits on the inside of handrail and aligns with the large on the outside. Use two 1/4 x 3/4" bolts, washers & nuts on the inside face and secure LOOSELY in the back two holes, only FINGER TIGHT (see 1.5-1.7). See 1.6 & 1.7 for proper placement of parts



1.6



1.7

READ ALL INSTRUCTIONS CAREFULLY

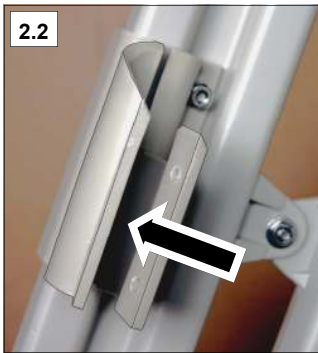

LEAVE HINGES LOOSE WITH GAP

It is important to secure the hinge sets (inner & outer) loosely so there remains a "gap" between the parts. This gap allows you to fit the gate in place between the inner & outer hinge pairs; both top & bottom (see 2.1 - 2.3)

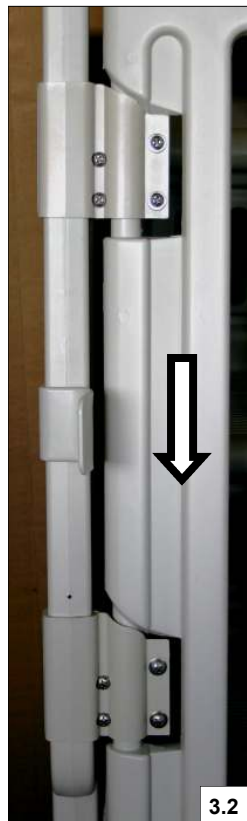
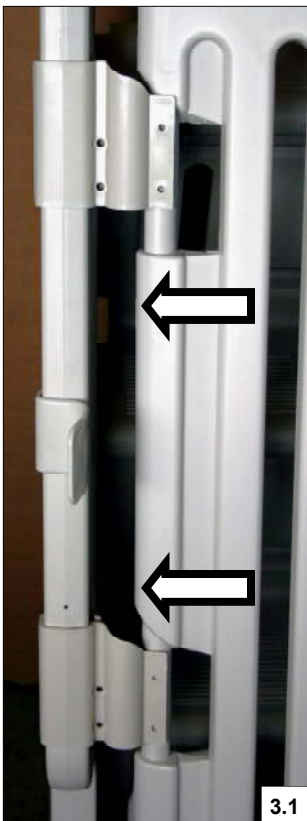

FIT & SECURE GATE

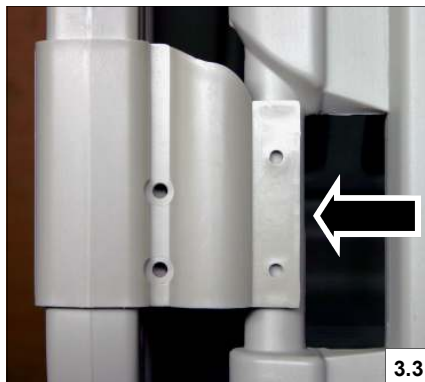

Gently pry open gate hinge sets & fit gate between the inner & outer hinge parts (3.1-3.3). The "round" posts of the gate will fit through the gap of the hinges (outlined in details above). Secure gate hinges using the remaining 1/4 x 3/4 bolts, washers & nuts. Note that the center holes only require the bolt & nut (no washers will fit). Tighten all hardware & make certain gate opens and closes smoothly.

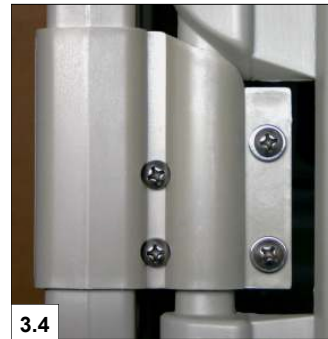

ATTACH GATE LATCH-STRIKER-SHIELD

Before attaching striker & latch, be sure gate is closed and pushed DOWN within hinge sets (see 3.2 above). Attach striker to gate (see 4.1). Striker is to be outside of gate, angled appropriately. Secure with 3/16 x 3/4" bolts, washers inside & nuts. Tighten hardware. With gate closed, down entirely, & striker in latch (see 4.2), position latch in the center of handrail and mark holes with pencil. Make certain striker is centered in latch correctly & latch is closed (see 4.2 & 4.3). Pre-drill 1/8" holes & secure using #10 x 3/4" screws (see 4.4). **DO NOT** over tighten screws as plastic may strip. Test gate to be sure it operates properly. Complete gate latch shield assembly. **LOCK GATE WHEN POOL IS NOT IN USE (4.5)**

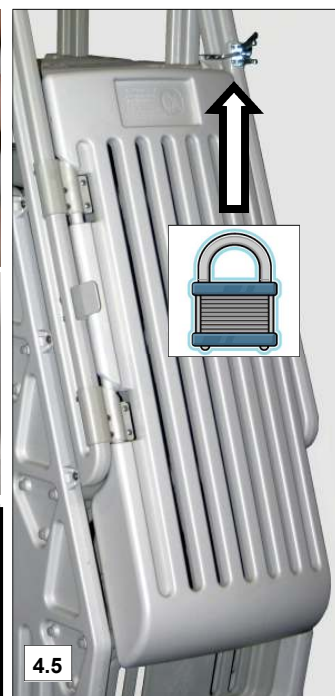
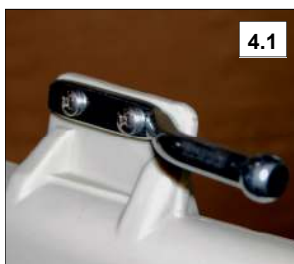

877-VINYL WK

www.vinylworkscanada.com



Recycle Responsibly

NOTHING REPLACES PARENTAL SUPERVISION

GATE LATCH SHIELD FOR MODEL # CE-AF-GE-G2D ENTRY SYSTEMS

MAKE CERTAIN TO READ & FOLLOW ALL INSTRUCTIONS CAREFULLY



Step 1: Identify all parts

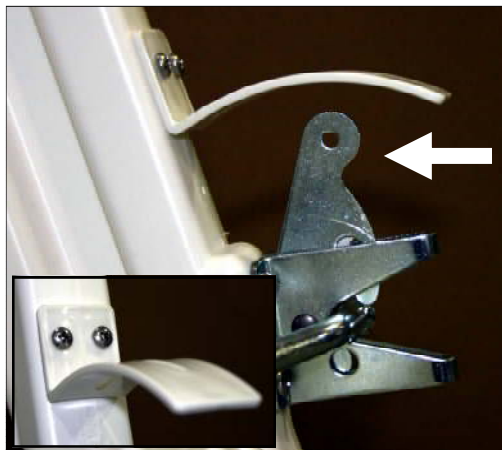

Step 2: Position latch shield above gate latch & check that latch has room to operate properly. Center shield & secure with 2 - #10 x 3/4 screws provided

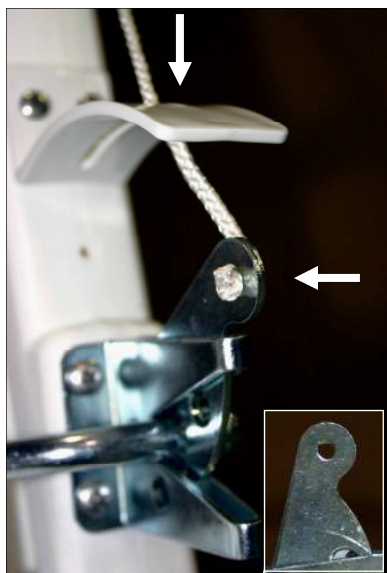

Step 3: Pass end of rope through slot in latch shield and through hole in gate latch. Tie end of rope into a knot so pulling rope will operate gate latch

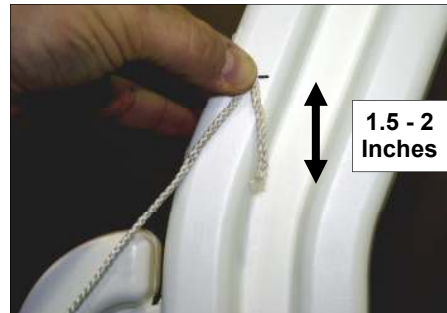
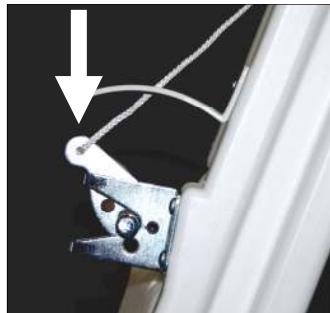

Step 4: Make sure gate latch catch is in down / locked position over striker bar. Extend string upwards to outside face of upper handrail & fold end approx. 1.5 - 2 inches. Mark handrail at fold in string for location of eye screw (see also Step 5 below)

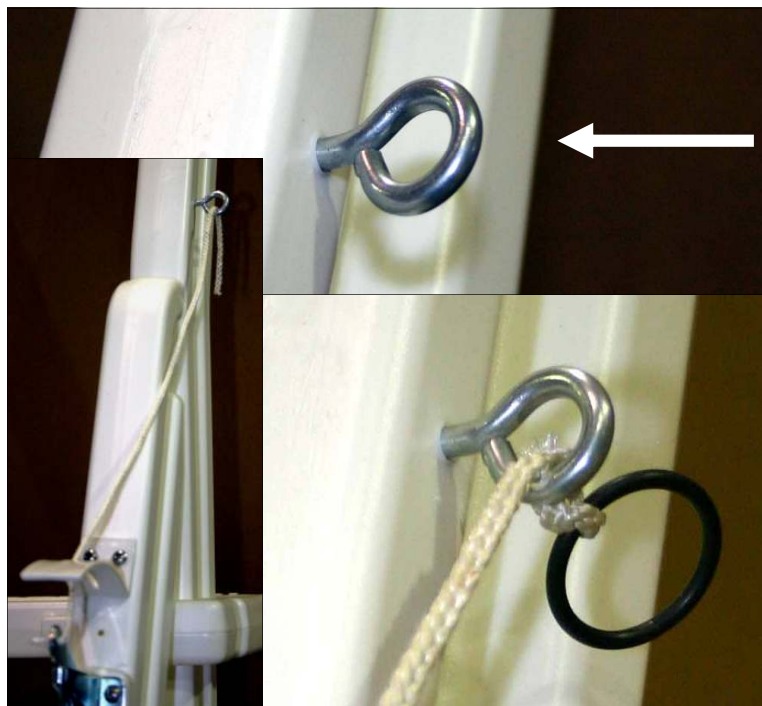

Step 5: Screw the eye screw into the outside of the upper handrail at the mark. Do not over-tighten. Pass end of rope through eye screw & tie knot tightly around finger ring

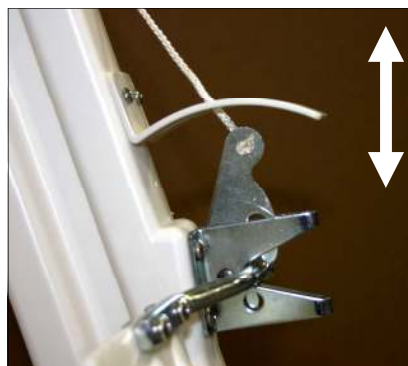

**MAKE CERTAIN
GATE REMAINS
CLOSED & LOCKED
WHEN POOL IS NOT
IN USE. REVIEW
PROPER USE OF
ENTRY & GATE
WITH ALL USERS OF
THE POOL**

Step 6: Pull finger ring numerous times to check for proper gate latch operation. It is extremely important that gate latch closes properly & freely over striker bar. Secure with lock

