

CARSON®

IS-200

HookUpz™ 2.0

SMARTPHONE OPTICS ADAPTER

Instructions for use

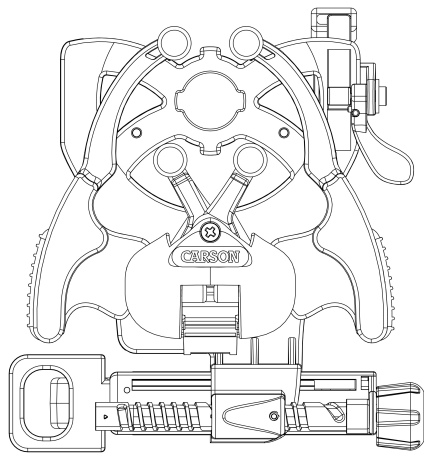

***Visit www.carson.com/hookupz2
to view our IS-200 tutorial video.***



HookUpz™

Table of Contents

Optic Side Diagram.....	2
Phone Side Diagram.....	3
Inserting Phone.....	4-5
Align & Lock.....	6-7
Attaching to Optic.....	8-10
Frequently Asked Questions.....	11-14
Tips and Tricks.....	15
Storage / Cleaning Information..	15
Customer Service.....	15
Compatibility.....	16

Carson Optical
2070 5th Avenue
Ronkonkoma, NY 11779

www.carson.com info@carson.com
Tel: 631-963-5000 Fax: 631-427-6749

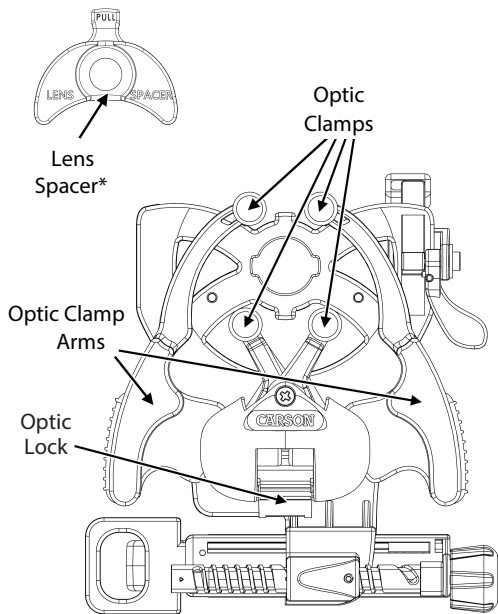

Optic Side

* See Frequently Asked Question 1 on page 11.

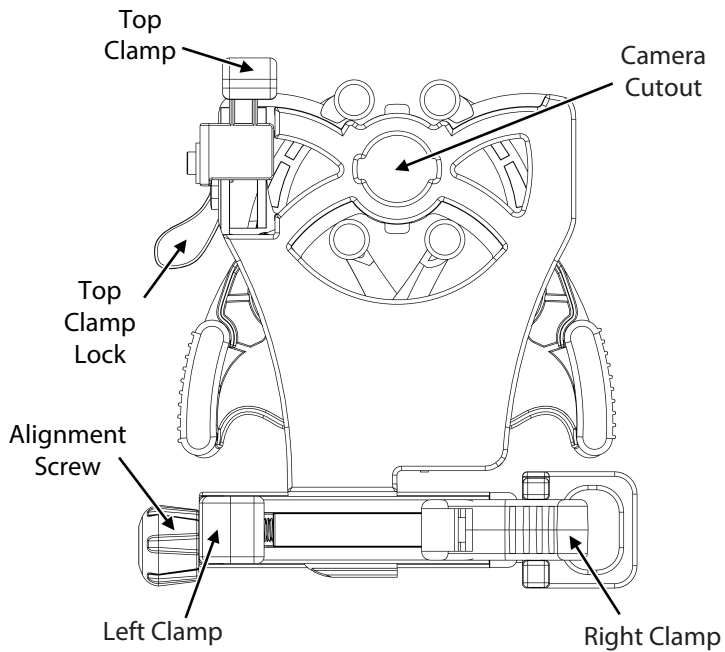

Phone Side

Inserting Phone

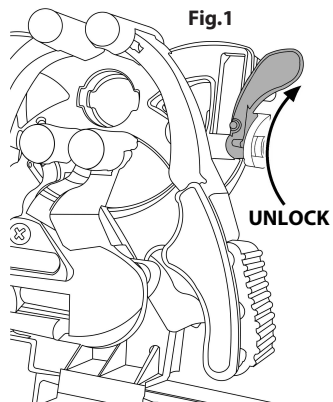

Rotate to unlock top clamp.

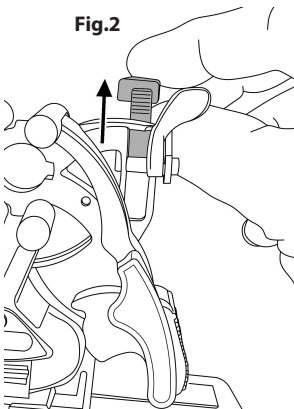

Slide top clamp into uppermost position.

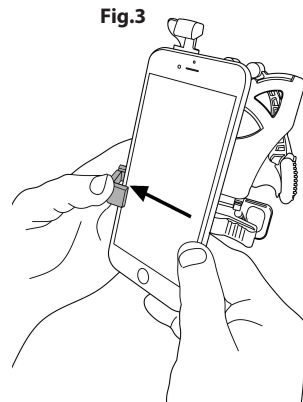

Insert phone into left clamp.

Inserting Phone (cont.)

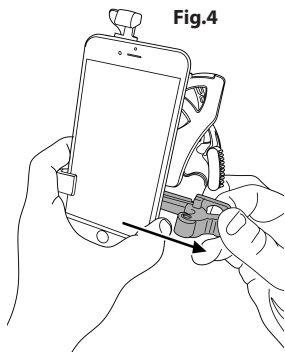

Squeeze and pull right clamp past edge of phone.

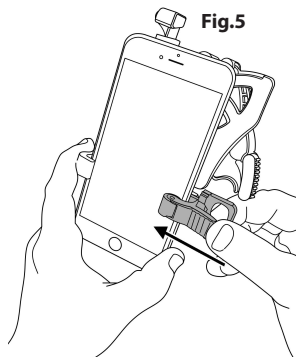

Release right clamp to secure phone.

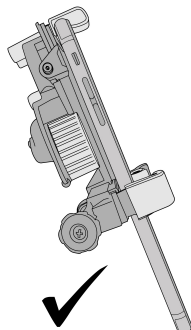

Ensure phone is flat as possible to adapter.

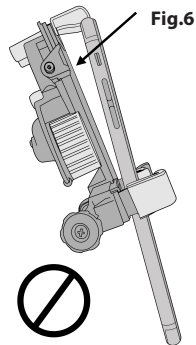

Align & Lock

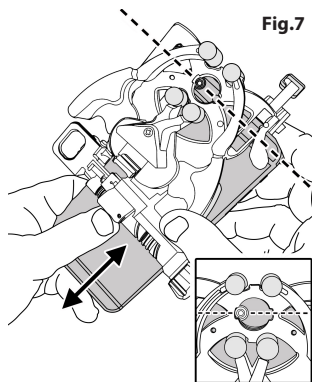

Slide phone vertically until camera is roughly aligned with camera cutout.

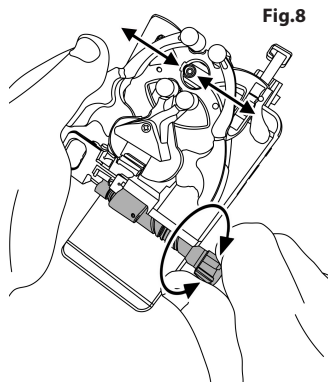

Turn alignment screw until camera is centered in camera cutout.

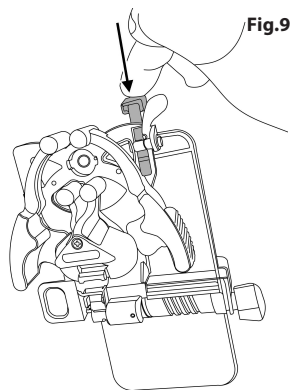

Slide top clamp down against phone edge.

Align & Lock (cont.)

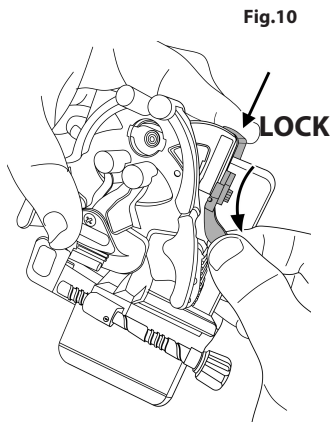

While holding top clamp tight to phone, rotate to lock.

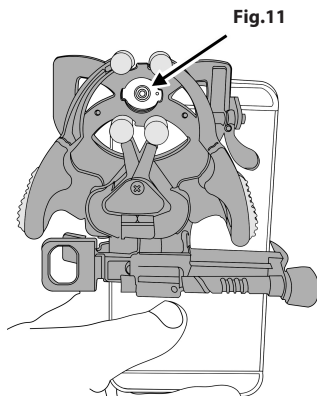
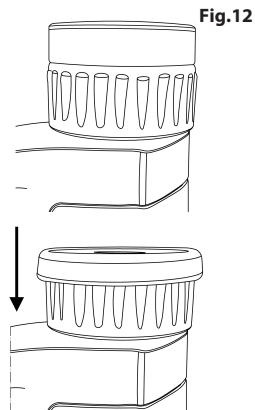

Figure 11 shows a properly aligned camera. If needed, use alignment screw and top clamp to make further adjustments.



Before attaching to optic, make sure your optic is focused. If your optic has flexible eyecups, remove eyecups (if possible) or fold down the eyecups before attaching adapter.

Attaching to Optic

Fig.13

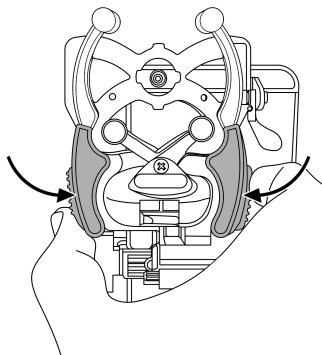

Squeeze arms to open optic clamp.

Fig.14

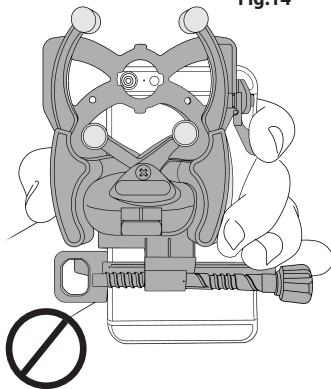

Do **NOT** squeeze arms while reaching around phone, otherwise phone alignment may be altered.

Fig.15

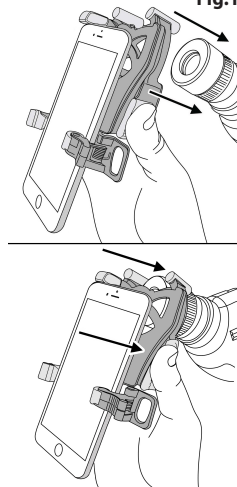

Once opened, place over eyepiece and release.

Attaching to Optic (cont.)

Fig.16

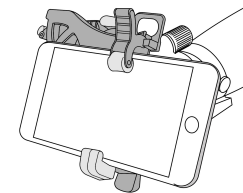
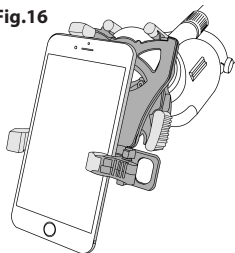

Phone can be positioned in either portrait or landscape mode.

Fig.17

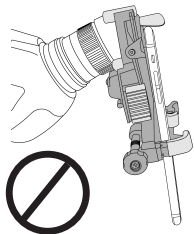
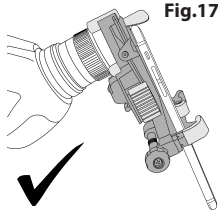

Ensure adapter is flush to the eyepiece of your optic.

Fig.18

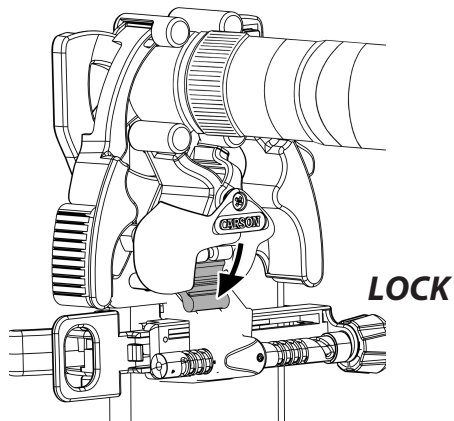

While attached to eyepiece, push optic lock down. This is required for use with smaller eyepieces, and not needed with larger eyepieces.

Attaching to Optic (cont.)

Fig.19

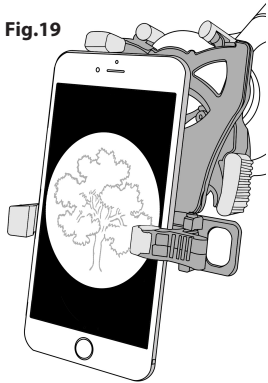

Turn on camera. If image is not centered, repeat alignment steps.

Fig.20

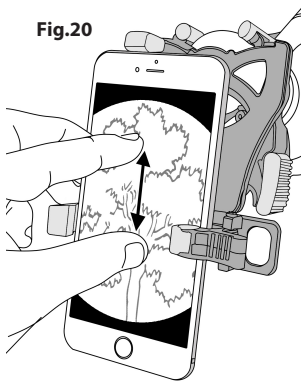

To maximize your image, pinch to enlarge image. For best results, use in video mode.

TO REMOVE OPTIC FROM ADAPTER:

Press optic clamp arms together to open adapter and remove from optic. To minimize an audible click noise, or if the optic lock does not release automatically, rotate it upwards to unlock.

TO REMOVE PHONE FROM ADAPTER:

To save your alignment, make no further adjustments to the top clamp and alignment knob. Simply remove phone using right clamp only as shown in Fig. 4.

USING ADAPTER AGAIN:

The alignment of your phone to the adapter should be saved from the initial setup, so many steps can be skipped (FIG 1-2, 7-10) and only a quick fine adjustment of the alignment may be needed.

Frequently Asked Questions:

Q1: What is the lens spacer for? **OR** Even if I pinch to zoom on my phone, my image is still a small circle?

A1: Depending on the combination of your phone and optic, to achieve the best image you may need to use the included lens spacer, especially for optics with small eyepieces (microscope, telescopes, etc.) or eyepieces with long eye relief. Insert and snap lens spacer into place as shown in figure below, and then reattach adapter onto optic. If the image size doesn't increase like figure below, then remove and do not continue to use lens spacer for that phone and optic combination.

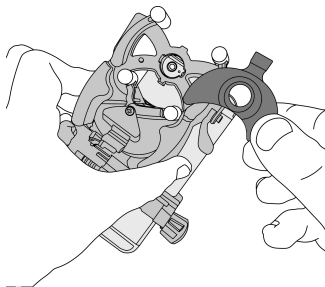

Squeeze open optic clamps and insert lens spacer in between clamps.

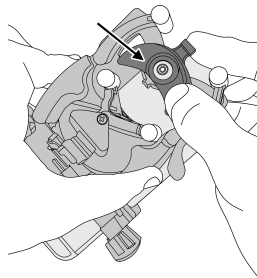

Snap lens spacer into place.

Q2: The top clamp touches the round corner of my phone not the top flat edge of my phone. What do I do?

A2: This is normal for some models of phones. Just push as flush to rounded edge as possible and lock top clamp as normal.

Frequently Asked Questions (cont):

Q3: I can't align my phone vertically with the top clamp, it won't fit. What do I do?

A3: If you go through the alignment process, and there is no way to achieve vertical alignment because it's restricted by the top clamp, try removing your phone case. Alternatively, you can remove top clamp assembly using screw as shown below in left figure. For this configuration, you will not be able to save your vertical alignment between uses, and will have to adjust for the vertical positioning of your phone for each time the phone is placed within adapter. Save these four parts for use with other phones, and you can reassemble the top clamp as shown below in right figure.

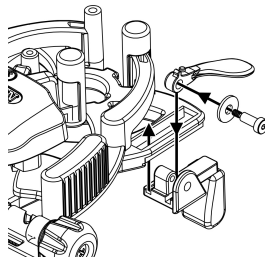
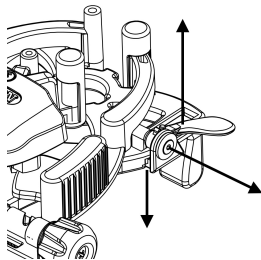

Q4: My phone or optic doesn't seem to work with adapter, how do I know which ones will work?

A4: Please see page 16 for compatibility guide.

Q5: Can I use this on my rifle scope?

A5: No, it is not recommend because of the long spacing required between the eyepiece of a rifle scope and your eye so that the image is very small on your phone screen. Also, we do not suggest using a firearm with the adapter on a rifle scope, due to recoil.

Frequently Asked Questions (cont):

Q6: My image is not centered or is not a complete round image, what is wrong?

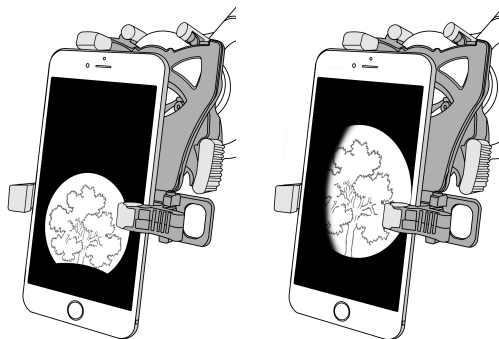

A6: Adjust phone alignment in vertical direction using top clamp (FIG 10), and in horizontal direction by using alignment screw (FIG 8). Check that phone is flat on adapter (FIG 6), and adapter is flush with optic (FIG 17).

Q7: My phone rotates on the eyepiece when used in landscape (horizontal) mode?

A7: If the eyepiece can rotate on your optic, then you can try the following:

- A. If your eyepiece can rotate outward, then you must place adapter in orientation to counter the rotation.
- B. If the eyepiece has any method to secure from rotation such as a set screw, use it to lock down the eyepiece.
- C. If you are not currently using the optic lock, then please use optic lock as per Fig. 18.
- D. If above solutions are not possible or do not work, for your application, it may not be possible to use in this mode. Please use only in portrait (vertical) mode.

Frequently Asked Questions (cont):

Q8: I am getting reflections and/or glare in my image, what do I do?

A8: If there are bright spots in the image itself, this may occur with indoor lighting, please avoid overhead lighting or change the angle over the overhead lighting relative to phone. Also, please use without flash to avoid reflections and/or glare in photos. If there is glare on your phone screen which makes image hard to view, then increase the brightness setting on your phone, and/or try to view from a position with less overhead lighting.

Q9: My other phone camera or flash is covered by adapter, why is that?

A9: First, we recommend using the device with only the primary rear camera. If problems persist, please contact customer support. Second, the flash can be covered, and is not needed for use with optic. We recommend flash setting is turned off at all times when using adapter.

Q10: I have a large eyepiece, but it seems like it won't fit or it's too tight to get on, what do I do?

A10: For eyepieces at the maximum range (58 – 62 mm), the adapter must be opened to its maximum, and then some pressure must be used to push the adapter over the eyepiece. Any eyepiece beyond 62 mm in external diameter should not be used with this adapter. For these largest eyepieces, do *not* use the optic lock. Also, it's important not to leave the adapter attached to these largest eyepieces for longer than two continuous hours, as it could cause permanent wear to the springs.

Q11: My phone has two cameras, which do I use?

A11: Always use the rear-facing camera. If there are two rear-facing cameras, use the primary one. With two rear-facing cameras, usually one is color (RGB) and one is black and white (monochromatic), so you want to use the color (RGB) one. If you don't know which rear-facing camera is the primary rear-facing camera, please refer to your phone's instructional manual.

Q12: The adapter is sagging on the eyepiece and not staying flush, what do I do?

A12: Make sure once the adapter is flush on the optic, to use the optic lock as shown in Figure 18.

Q13: Does this work on a tripod?

A13: No, the adapter itself does not have a tripod mount. However, for best stabilized images and videos, we suggest the optic used is mounted to a tripod.

Tips & Tricks:

PHOTOGRAPHY

- Tap object of interest on your phone screen to autofocus.
- For videos, tap and hold object of interest on phone screen for a second to lock focus. Tap again to release the focus lock.
- In low light conditions, turn your phone screen brightness to its lowest level. The rubber parts glow in the dark making it easier to use the adapter.
- For long sessions, try using battery cases or phone chargers to prevent your battery from draining.

APPS

- Share photos and videos through various apps (e.g. FaceTime, Messages, Facebook, Instagram, etc.)
- Apps that allow you to set exposure and focus manually can expand the potential of the adapter. This is especially helpful for telescopes to set longer exposure times to get the best images of sky objects.

STABILIZATION

- Mount your optic to a tripod or place on a stable surface to prevent external vibrations from shaking image.
- To prevent shaking while capturing photos, attach headphones to smartphone and use the volume buttons to activate shutter.
- Many phones have image stabilization features. Check your phone and turn on this feature if available. If not, there are camera apps with stabilization features.

Storage/Cleaning Information:

- To avoid damage, always store adapter in protective case when not in use.
- For longest life of springs/plastic, store in dry area at room temperature.
- Do not leave item permanently attached to optical device as this may weaken the springs over time.
- Adapter should be cleaned with soft, damp cloth only. Do not use any chemicals or abrasives.

Customer Service:

We will be happy to help you with any problems you may experience with your HookUpz™ Pro Smartphone Optics Adapter. Email us at info@carson.com or call toll-free at 1-800-967-8427.

Tips & Tricks:

PHOTOGRAPHY

- Tap object of interest on your phone screen to autofocus.
- For videos, tap and hold object of interest on phone screen for a second to lock focus. Tap again to release the focus lock.
- In low light conditions, turn your phone screen brightness to its lowest level. The rubber parts glow in the dark making it easier to use the adapter.
- For long sessions, try using battery cases or phone chargers to prevent your battery from draining.

APPS

- Share photos and videos through various apps (e.g. FaceTime, Messages, Facebook, Instagram, etc.)
- Apps that allow you to set exposure and focus manually can expand the potential of the adapter. This is especially helpful for telescopes to set longer exposure times to get the best images of sky objects.

STABILIZATION

- Mount your optic to a tripod or place on a stable surface to prevent external vibrations from shaking image.
- To prevent shaking while capturing photos, attach headphones to smartphone and use the volume buttons to activate shutter.
- Many phones have image stabilization features. Check your phone and turn on this feature if available. If not, there are camera apps with stabilization features.

Storage/Cleaning Information:

- To avoid damage, always store adapter in protective case when not in use.
- For longest life of springs/plastic, store in dry area at room temperature.
- Do not leave item permanently attached to optical device as this may weaken the springs over time.
- Adapter should be cleaned with soft, damp cloth only. Do not use any chemicals or abrasives.

Customer Service:

We will be happy to help you with any problems you may experience with your HookUpz™ Pro Smartphone Optics Adapter. Email us at info@carson.com or call toll-free at 1-800-967-8427.

SMARTPHONE SIZING GUIDE

If your phone (in it's case) fits in "portrait" orientation between the 2 arrows, it will fit the HookUpz™ 2.0 Adapter

OPTIC SIZING GUIDE

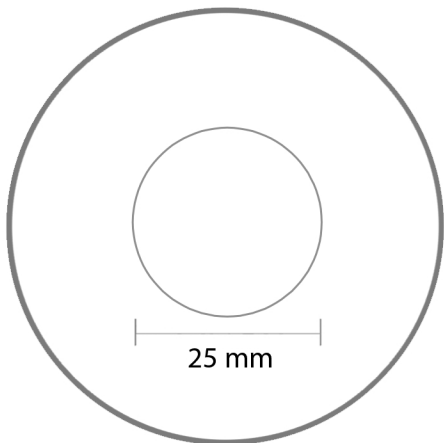

OPTIC SIZING INSTRUCTIONS:

1. Place your optic's eyepiece inside one of the two circles on the left.
2. If your optic's eyepiece fits in between the 25 mm to 58 mm circles, then the Hookupz 2.0 will fit your optic!
- * 3. For eyepieces up to 60 mm, push firmly to secure.

DOES NOT FIT IRREGULAR SHAPE EYEPIECES OR RIFLESCOPES:

