

# ST. CROIX IN POOL LADDER

## MODEL AC 26395

**FOR USE WITH:  
THE CURACAO  
32" GATED  
ENTRY STEP WITH  
IN POOL LADDER  
(BS ATLENTGT)**

### **CARTONS REQUIRED**

- (1) AC 30163—Antigua Steps
- (1) AC 70807—Pickets
- (1) AC 30988—Gate
- (1) AC 26395—St Croix In Pool Ladder



The enclosed ladder will attach to the Antigua step (**AC 30163**). Please open the step carton and assemble the step per the instructions. Refer to this book for instructions on the assembly and attachment of the ladder when instructed in step manual.

### **TOOLS REQUIRED**

- Drill with 1/8" drill bit
- Small rubber mallet or hammer w/piece of wood
- Phillips head screwdriver
- Pliers
- Spray lubricant or liquid soap
- 40 Lbs. of Sand
- Funnel
- Hacksaw

# ST. CROIX LADDER PARTS

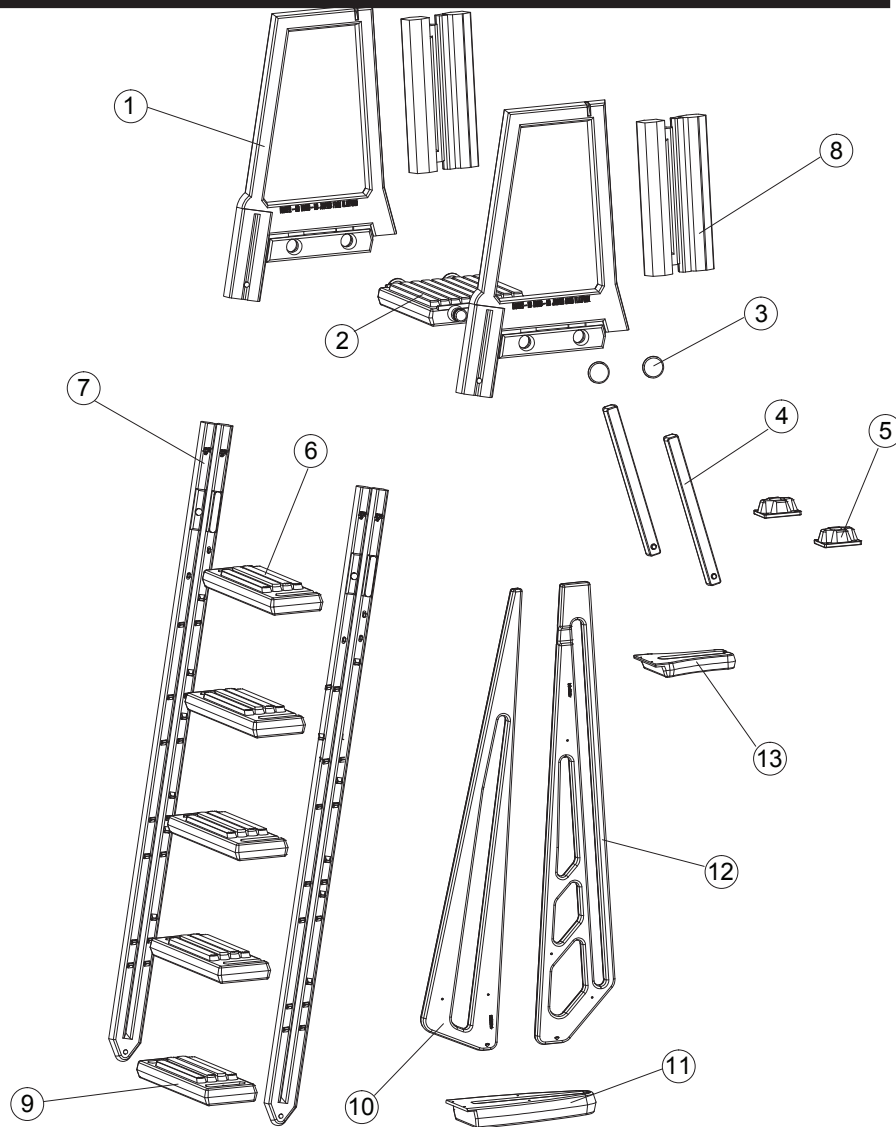

PART #	MODEL #	DESCRIPTION	QTY
1	AC HANDRAIL	Handrail	2
2	AC PLATFORM	Platform	1
3	AC LOCKCAP	Lock Cap	4
4	AC ADJTUBE	Adjustable Tube	2
5	AC MTBLOCK	Mounting Blocks	2
6	AC MDSTEP	Upper Step	4
7	AC 01129	Capri Leg	2
8	AC SHIELD	Shield	2
9	AC BTSTEP	Bottom Step	1
10	AC 01124	Small Barrier	1
11	AC 01126	Lower Base	1
12	AC 01123	Lsrge Barrier	1
13	AC 01125	Upper Brace	1
14	AC 01130	Hardware Bag	1

# IMPORTANT SAFETY INSTRUCTIONS PLEASE READ PRIOR TO ASSEMBLY/USE

The Ladder must be installed based on **Manufacturer's Instructions**

- One person on the Ladder/Stair at a time
- This Ladder is designed and manufactured for a specific Pool Wall Height and/or Deck of the Pool
- For Entry/Exit of pool, face the ladder at all times
- Remove and secure Ladder when pool is not occupied
- The Ladder will be suitable up to 54" Maximum Pool Height
- There shall be clearance of Min. 3" and Max. 6" between the Pool Wall and the Ladder

## STEP 1

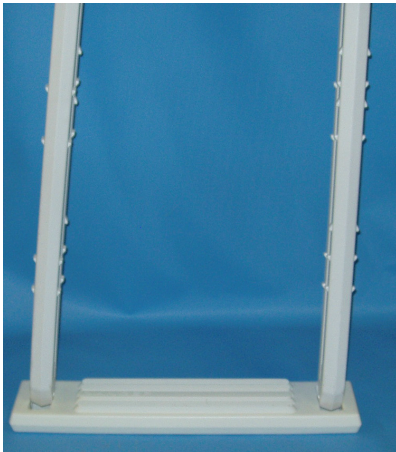

- Place the bottom step (**AC BTSTEP**) on a level surface with indentations facing up.
- Take leg (**AC 01129**) and stand upright (pointed side down). When installed on bottom step, the leg will need to have the raised areas facing inward. The raised area with the pre-drilled screw hole should be at the front of the ladder toward the top of the leg.
- Place the left leg into the indentation on the left side of the step and push straight down until it clicks into place.
- Repeat above for right leg on right side of step.

## STEP 2

- There are two sets of lug locations on the stringers in the areas where each step will be installed. Each step should be installed into the UPPER set of lugs only.
- Locate one of the four groups of lugs and slide step (**AC MKSTEP**) into the upper set of lugs on the legs so it clicks into place.
- Repeat for each of the remaining (3) steps.
- Secure all by drilling (1) #10 x 1-1/4" screw into each side of the step through the pre-marked leg openings.

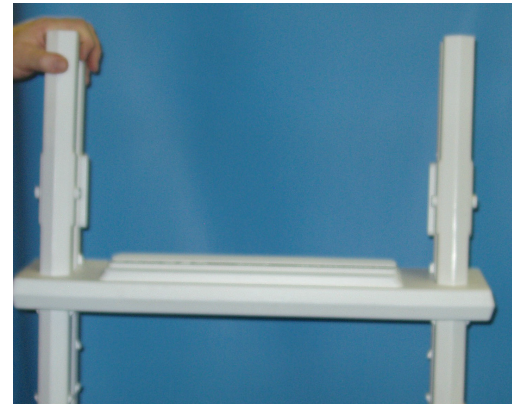

## STEP 3



- Place the Lower Base (**AC 01126**) on a level surface.
- Snap Large Barrier (**AC 01123**) into the groove on the lower base facing round edge.
- Snap Small Barrier (**AC 01124**) into the groove on the lower base facing the straight side.

- Slide Upper Brace (**AC 01125**) over Small Barrier as shown.



- Slide Upper Brace (**AC 01125**) through the groove in the Large Barrier and push down lightly to secure.



- Screw Lower Base of Entrapment Barrier into bottom step of the Inside Portion of the Ladder with (2) #10 x 1-1/4" screws.



- Screw Upper Brace of Entrapment Barrier into the third step of the Inside Portion of the Ladder with (2) #10 x 1-1/4" screws

## STEP 4



**NOTE** Follow this step if using as an In Pool Ladder

- This Ladder is designed to fit multiple pool heights. **ONLY FOLLOW THIS STEP IF YOUR POOL HEIGHT IS 48"**.
- Locate the leg (**AC 01129**) on both sides of the ladder.
- Find the lines located at the top of the legs.
- Using a hacksaw cut both legs evenly along the line.

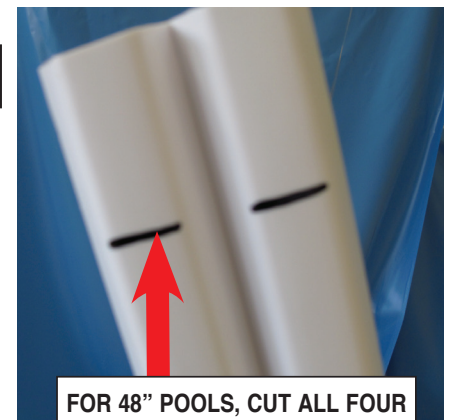

**FOR 48" POOLS, CUT ALL FOUR LEGS AT THIS LINE**



## STEP 5

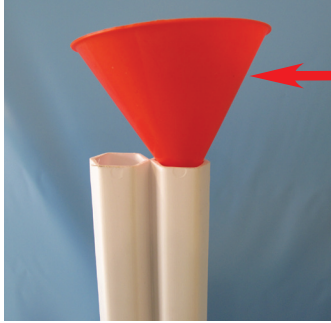

FILL LEGS WITH SAND  
USING A FUNNEL

- Using a funnel fill both legs with sand. Use approximately 20 Lbs. of sand in each leg.

## STEP 6



- Put ladder aside for now and install handrails (**AC HANDRAIL**) onto platform (**AC PLATFORM**).
- Lay one handrail on flat surface and push the connected dowels of the platform into the openings on the handrail until fully seated. Make sure treads of platform are facing upward.
- Before attaching second handrail, make sure that the longer part of the handrail is facing in the same direction on both handrails. Repeat above for installation of second handrail.

- Center locking cap (**AC LOCKCAP**) over opening on side of handrail where platform was just attached. Using a rubber mallet or a hammer and a small piece of wood, tap on cap until the cap is flush with the handrail
- Repeat for each of the remaining (3) locking caps.
- Coat the tops of the legs with lubricant and attach handrails by pushing them down over the legs. Secure with (4) #10 1-1/4" screws through each of the pre-marked openings.





- NOTE**
- If attaching to a Deck proceed to **STEP 7**
  - If attaching to a Step to create the Curacao Entry System proceed to **STEP 8**

## STEP 7—DECK MOUNT

- Coat adjustable tube (**AC ADJTUBE**) with lubricant and slip (1) mounting block (**AC MTBLOCK**) all the way down over the nubs on the tube. The open side should be exposed.
- Repeat for second adjustable tube and mounting block.
- Push one adjustable tube into the longer part of each handrail. The mounting block should sit on the top step to hold the ladder in place. Secure into handrail using (4) #10 1-1/4" screws in pre-marked openings.
- Move tube down to deck until it rests on the deck. Using the proper hardware (not included) screw mounting blocks into decking through the pre-drilled holes.

## STEP 8 — CURACAO ENTRY SYSTEM



- To attach the ladder to the step assembly, you will need to attach the shield (**AC SHIELD**).
- Line the shield up above the handrail and push it down so it slides onto the handrail. Repeat for opposite side.
- Rotate shield 90 degrees, so that the open sleeve of each shield is on the outside (see photo).

## STEP 9



- Once shields are situated properly, lift ladder up and line up the openings of shield with long handrail posts of the step.
- Slide the ladder down until it rests on ground outside.

## STEP 9 CONT.

- Coat adjustable tube (**AC ADJTUBE**) with lubricant and slip (1) mounting block (**AC MTBLOCK**) all the way down over the nubs on the tube. The open side should be exposed.
- Repeat for second adjustable tube and mounting block.

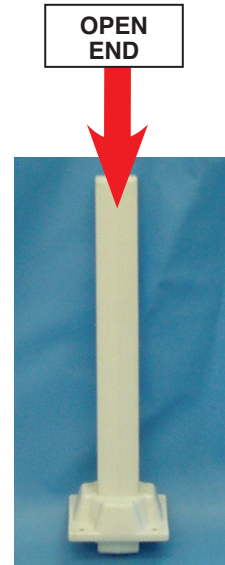

- Push one adjustable tube into the longer part of each handrail. The mounting block should sit on the top step to hold the ladder in place. Secure into handrail using (4) #10 1-1/4" screws in pre-marked openings.
- Secure each mounting block to the top step of the staircase using (4) #10 1-1/4" screws per mounting block.
- Fasten the shields to the handrails using (8) #10 1-1/4" screws (4 per side).

## STEP 10

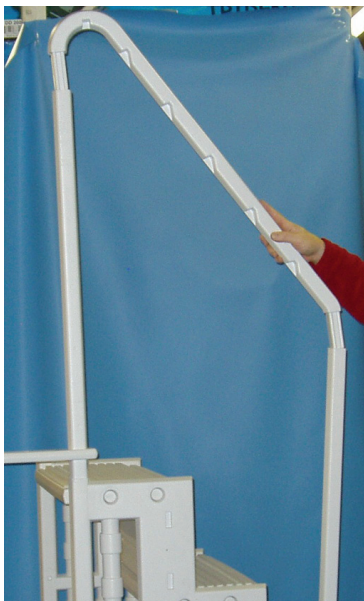

- Lubricate inside of long and short handrail posts on step with liquid soap or lubricant.
- Attach handrails from step box (**AC 30163**) to handrail posts by pushing into posts. The more curved part of the handrail is meant to be installed in the long handrail post.
- Using (4) screws from step box (**AC 30163**) hardware bag, secure handrails in place.



**NOTE** If attaching Gate System. Please refer to instructions packed in carton marked AC 30988

## SAFETY INFORMATION

- When lifting heavy or awkward loads, it is suggested that two people lift to avoid injury.
- **DO NOT** use the pool entry system for any purpose other than that for which it is intended.
- Maximum weight on steps should **NOT** exceed 350 lbs.



**WARNING** Exceeding the recommended weight limit may cause the step to fail and may result in injury.

## MAINTENANCE

- Step/ladder/bridges must be removed for winter, failure to do so can cause the step to crack.
- When removing step/ladder/bridges for winter, it is recommended that you spray down step with hose water to rinse off any chemical residual prior to storing.
- When storing step/ladder/bridges for winter, they should be protected from the elements and stored either in a shed or garage, or covered with a tarp.

## LADDER MATS

- The use of a ladder mat is **STRONGLY RECOMMENDED** with any pool ladder. Ladder mats prevent your pool liner from being damaged by slight movements of your pool ladder.

## HOW TO INSTALL YOUR LADDER MAT

1. Remove ladder mat from packaging
2. Place ladder mat onto the bottom of the pool with the smooth side facing down towards the liner
3. Place fully assembled ladder on top of the ladder mat. Make sure the ladder is centered on the ladder mat
4. Properly secure ladder to your pool

**USE MODEL BS 17922  
9" x 24" MAT**

**LADDER MATS ARE SOLD SEPARATELY  
FROM YOUR POOL LADDER**

