

# ANTIGUA STEP WITH OPTIONAL STEP BRIGHT LIGHT

## **MODEL AC 30163**

(1 CARTON)

## **MODEL AC 08478**

Below are the options available with use of the Antigua Step. The cartons and instructions necessary will vary depending on which set-up you have purchased. Please find the model you purchased on the next page and note the information regarding location of the instructions and assembly.



**FOR USE WITH:  
CAYMAN  
STEP W/FLIP UP  
OUTSIDE LADDER (AC LDR)**

### **CARTONS REQUIRED**

- (1) AC 30163—Antigua Steps
- (1) AC 30473—Outside Ladder
- (1) AC 30163—Antigua Steps



**FOR USE WITH:  
THE CURACAO  
GATED ENTRY WITH  
IN POOL LADDER (AC ATLENTGT)**

### **CARTONS REQUIRED**

- (1) AC 30163—Antigua Steps
- (1) AC 70807—Pickets
- (1) AC 30988—Gate
- (1) AC 26395—St Croix In Pool Ladder



**FOR USE WITH:  
TRINIDAD  
BRIDGE SYSTEM  
(AC BRIDGE)**

### **CARTONS REQUIRED**

- (2) AC 30163—Antigua Steps
- (1) AC 30937—Cross Over and Pickets
- (1) AC 30988—Gate

# IMPORTANT SAFETY INSTRUCTIONS PLEASE READ PRIOR TO ASSEMBLY/USE

The Ladder must be installed based on **Manufacturer's Instructions**

- One person on the Ladder/Stair at a time
- This Ladder is designed and manufactured for a specific Pool Wall Height and/or Deck of the Pool
- For Entry/Exit of pool, face the ladder at all times
- Remove and secure Ladder when pool is not occupied
- The Ladder will be suitable up to 54" Maximum Pool Height

## ANTIGUA STEP (AC 30163)

This carton (**AC 30163**) contains ALL the necessary pieces and instructions for installation of your new step. Please follow all instructions for proper installation of this step.

## CAYMAN ENTRY SYSTEM (AC LDR)

This is carton 1 of 2. The step and the necessary instructions for installation are included within this carton. You should have a second carton labeled (**AC 30473**) which contains the outside ladder for this system. All the necessary instructions for installation of the ladder are located inside the second carton.

## CURACAO GATED ENTRY WITH IN POOL LADDER (AC ATLENTGT)

There are four cartons necessary to install your entry system. You should have 1 step carton (**AC 30163**) which includes the instructions necessary to install the step only. The second carton is marked (**AC 26395**) and this contains the In Pool Ladder as well as assembly and attachment instructions to the step. Cartons three and four are (**AC 30988**) Gate and (**AC 70807**) Pickets each box contains assembly and attachment instructions to enclose your entry system.

## TRINIDAD BRIDGE SYSTEM (AC BRIDGE)

There are four cartons necessary to install your new bridge. You should have 2 step cartons (**AC 30163**) which include the instructions necessary to install the steps only. The third carton is marked (**AC 30937**) and this contains the crossover necessary to connect the two steps. The instructions for the assembly and installation of the crossover are located in the crossover box. Carton 4 is the gate carton (**AC 30988**) which includes the necessary components for the gate and instructions for gate installation.



**NOTE** The sequence of the instructions may vary at points depending on the type of step system that you have purchased. If there are different instructions for your system, it **WILL BE** indicated within the step. Please follow these notes to avoid additional steps and wasted time.

## TOOLS REQUIRED

- Small rubber mallet or hammer w/piece of wood
- Phillips head screwdriver
- Pliers
- Liquid soap or lubricant
- 40 lbs. of sand (sold separately)
- Funnel

# PARTS & HARDWARE FOR STEP



**A. LONG HANDRAIL POST (2)**  
(AC LONGPOS)

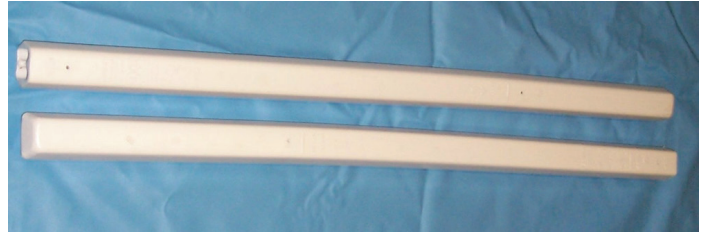

**B. SHORT HANDRAIL POST (2)**  
(AC SHORTPOS)

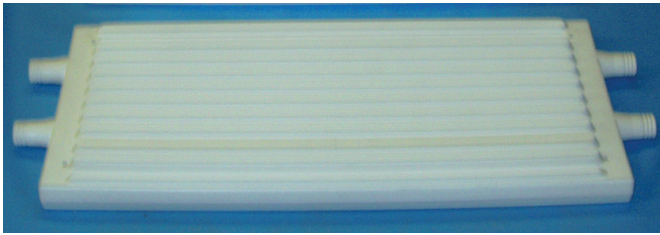

**C. STEPS (4)**  
(AC STEPS)



**D. RISERS (4)**  
(AC RISERS)



**E. BASES (2)**  
(AC BASE)



**F. MOUNTING BRACKETS (2)**  
(AC MTBRACK)

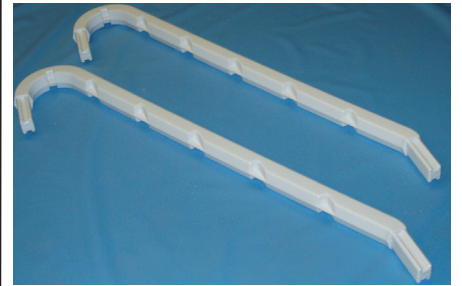

**G. HANDRAILS (2)**  
(AC STEPRAIL)

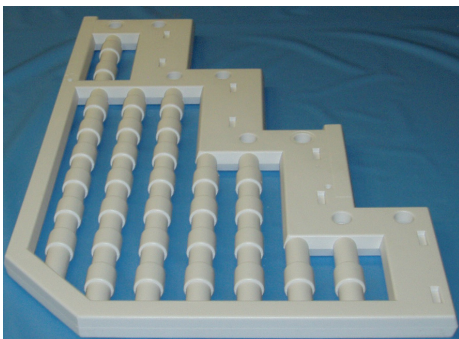

**H. SIDE PANELS (2)**  
(AC PANELS)



**K. DANGER STICKERS**  
(AC DNGRSTIK)



**M. STEP BRIGHT LIGHT**  
(AC 08478)



**J. HARDWARE**  
(AC HDW30163)  
• 14 - 1-1/4" screws



**I. LOCK CAPS (16)**  
(AC LOCKCAP)

# ANTIGUA STEP PARTS

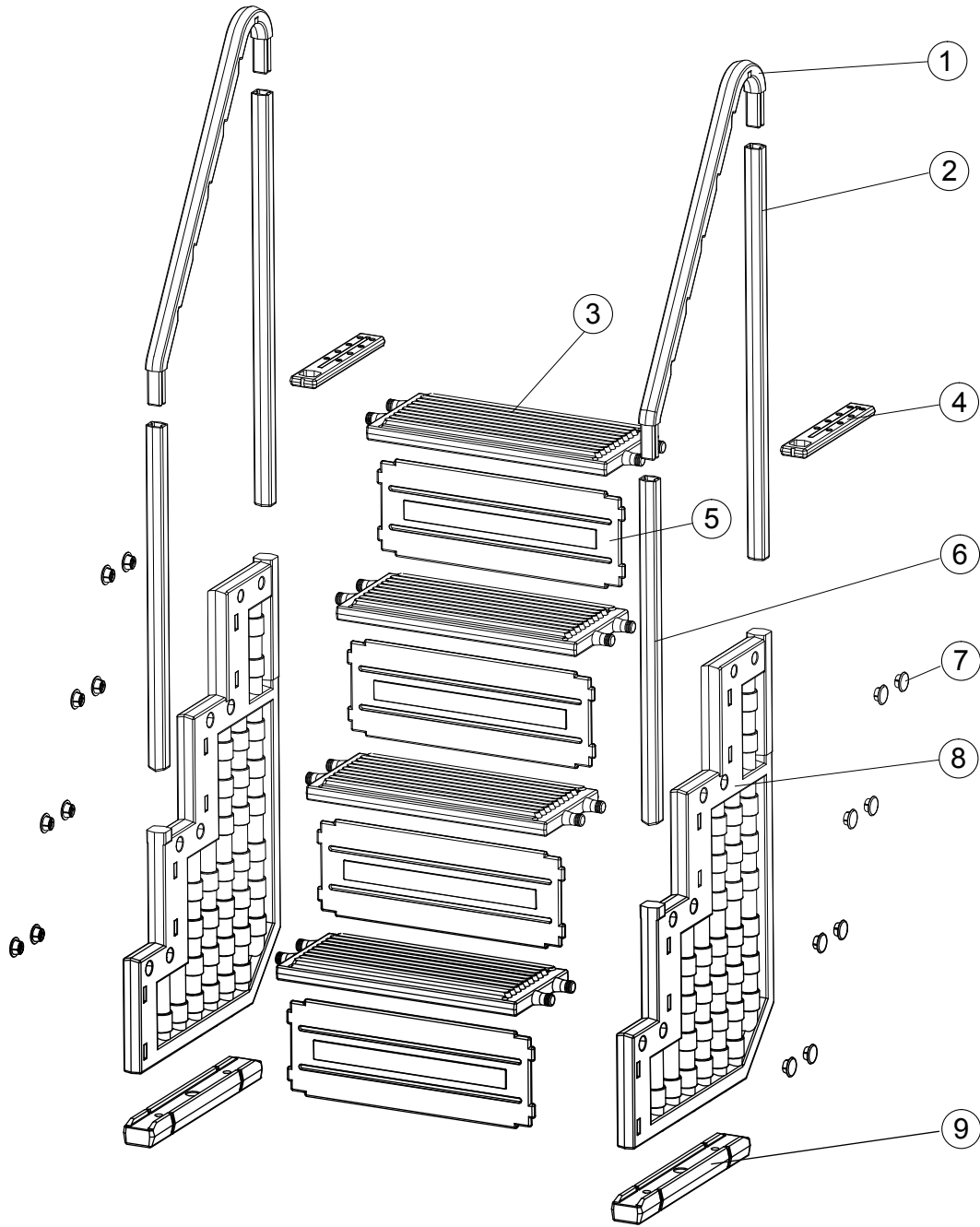

PART #	MODEL #	DESCRIPTION	QTY
1	AC STEPRAIL	Steprail	2
2	AC LONGPOS	Long Post	2
3	AC STEPS	Steps	4
4	AC MTBRACK	Mounting Bracket	2
5	AC RISER	Step Raisers	4
6	AC SHORTPOS	Short Post	2
7	AC LOCKCAP	Lock Caps	16
8	AC PANELS	Side Panels	2
9	AC BASE	Step Base	2

## STEP 1

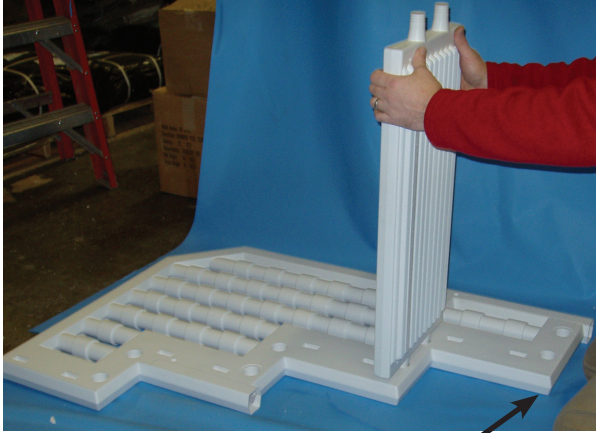

TOP OF PANEL

- Lay one of the side panels (**H**) down on a flat surface.
- Each step (**C**) has a groove where the riser will slide in which is located on the bottom of each step.
- Line up a step (**C**) by positioning the connected dowels on the step with two of the round holes on the side panel (**H**). **NOTE:** Make sure that the treads on the step are facing towards the TOP of the side panel (the skinnier part of panel) and that the riser groove on the step is towards the back of the step.
- Push the step until it clicks in place. Repeat for each of the three remaining steps (**C**). If necessary, you may use the rubber mallet or hammer with wood on top to tap into place.

## STEP 2

- Insert a riser (**D**) between each of the steps. Locate the hole in the center of the riser. This hole should face towards the back of the side panel.
- The riser should slide right into the grooves on the steps and the square notches should fit right into the recessed openings on the panel.
- Elect the riser position you want the light to be installed and slide the step bright riser into that position. (Note: you will have an extra riser when assembly is complete)
- Repeat for each of the three remaining risers.

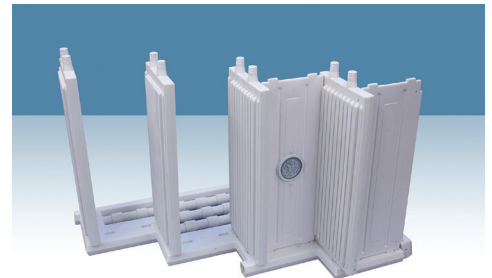
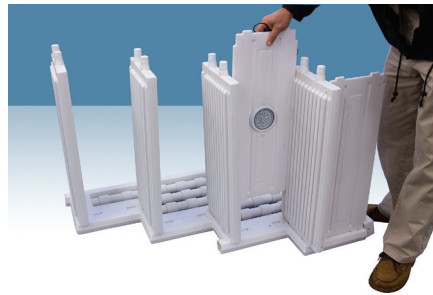

## STEP 3



- Once all risers are in place, line up second side panel with the connected dowels on installed steps.
- Push down on side panel to lock in place, if necessary use rubber mallet or (hammer with piece of wood) to fully seat side panel.

## STEP 4



- Leave the side panel facing upward and position one of the lock caps (I) centered over any hole on the side panel.
- Using a small rubber mallet or a (block of wood and a small hammer), tap on the locking cap until it is secured over the pin sticking through the side of the step and is flush with the side panel.
- Repeat this procedure for each of the additional seven openings on this side of the step.
- Flip step so that other side panel is facing upwards and repeat above for the eight holes on this side.

## STEP 5

- Leave the side panel facing upward and position one of the bases (E) under the side panel with the channel against the step.



- Secure the base to the side panel with two zip ties. There is a molded groove in the base for placement of the zip tie. Tighten zip tie securely.
- Repeat for opposite side.



**NOTE** Zip tie should catch and lock when pulled tight, if it does not then turn the zip tie over and reattach.



**NOTE** To prevent damage to liner, make sure that the locking tab on zip tie is positioned so that it will NOT come in contact with liner.

## STEP 6

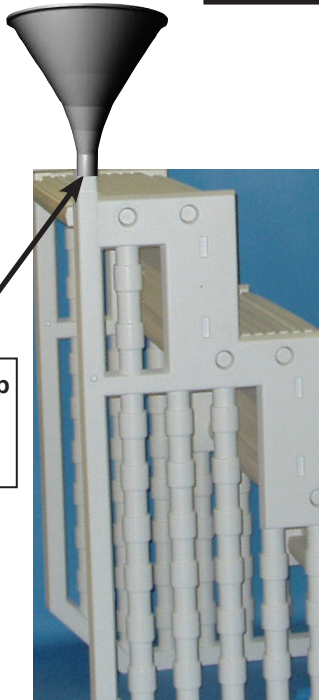

Place funnel up here and pour sand through these posts

- Skip this Step if optional Step Weights (AC 70033) are being used.
- In order for step to sit properly, it must be weighted in place using approximately 50 lbs of sand. To weight step, place funnel in opening of side panel on top step. Pour 25 Lbs. of sand into each side of the step.



**NOTE** You may need to rock the step back and forth to distribute the sand so the 25 Lbs. will fit in each side of the step.

## STEP 7

- Place the assembled step INSIDE the pool where you would like to enter the pool. **\*\*When lifting the step into the pool it is recommended that two people lift to avoid injury.** Filter should be turned off to stop water circulation.



- Once step is placed in the pool, tip the step forward and move it left and right to ensure that air escapes and water enters the steps and risers. This will help keep the step stationary in the pool.



**NOTE** When installing a step inside of your pool it is recommended to install a step mat underneath to protect your liner. This item is sold separately.

## STEP 8

- The two long handrail posts (**A**) should be installed into the holes located at the back of the step.
- When installing these posts, make sure that the closed end goes into the opening and that the open end is facing up.
- Once in place, secure using (2) screws from hardware bag (**J**).

**NOTE** If you are having a problem getting the handrail posts in due to the sand, rock the step left and right to distribute sand.



**\*\*IF YOU ARE INSTALLING THE CAYMAN ENTRY SYSTEM, PLEASE REFER TO AC 30473 INSTRUCTIONS AT THIS TIME.**

**\*\*IF YOU ARE INSTALLING THE TRINIDAD BRIDGE SYSTEM, PLEASE REFER TO AC 30937 INSTRUCTIONS AT THIS TIME.**

## STEP 9



- If you are reading this step, then you will be attaching this staircase to an existing deck at the pool site. If you are NOT installing this step to a deck, please refer to the above notes for your next step.
  - Locate mounting brackets (**F**) and slide one over each of the long handrail posts. These will be used to secure your step to your decking.
  - Adjust mounting brackets height-wise so that they are even with your deck. Once these are even, make sure step is where you would like it in pool. Make sure the upright posts are as close as possible to pool top rails.
- Attach mounting brackets by screwing into deck through two of the three holes on each mounting bracket (choose the openings that best fits your deck). The screws necessary for attachment are NOT included as there are several types of deck materials and the necessary screws will vary.

**NOTE** Step **MUST** be secured to deck to prevent rocking or tipping. If the mounting brackets do not reach the deck, you will need to extend that part of the deck surface so that the brackets can be screwed in place.



## STEP 10



- Lubricate inside of long and short handrail posts with liquid soap or lubricant.
- Attach handrails (**D**) to handrail posts by pushing into posts. The more curved part of the handrail is meant to be installed in the long handrail post.
- Using (4) screws from hardware bag (**J**), secure handrails in place.
- Stick one danger sticker (**K**) on each handrail so that one faces inside the pool and the other faces the outside.

## SAFETY INFORMATION

- When lifting heavy or awkward loads, it is suggested that two people lift to avoid injury.
- **DO NOT** use the pool steps for any purpose other than that for which it is intended.
- Maximum weight on steps should **NOT** exceed 350 lbs.



**WARNING** Exceeding the recommended weight limit may cause the step to fail and may result in injury.

## MAINTENANCE

- Step/ladder/bridges must be removed for winter, failure to do so can cause the step to crack.
- When removing step/ladder/bridges for winter, it is recommended that you spray down step with hose water to rinse off any chemical residual prior to storing.
- When storing step/ladder/bridges for winter, it should be protected from the elements and stored either in a shed or garage, or covered with a tarp.

## STEP 11

- The low voltage wire running from the light to the controller can be run under the step and under the mounting bracket if using with an existing deck.



- The low voltage wire can then be run down under the deck to the control pad and transformer.

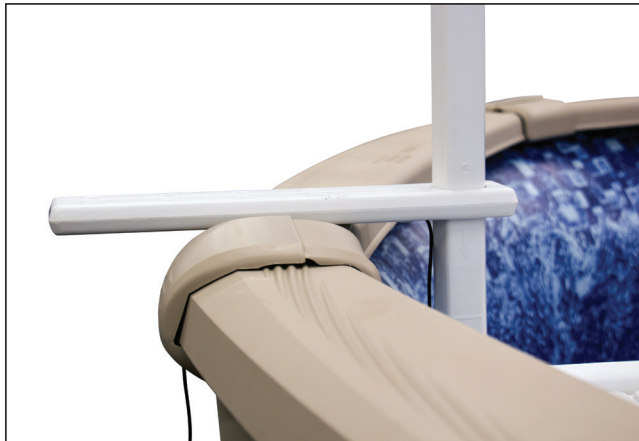

- The control pad can be mounted on the side of an existing deck or post outside the pool.

**For Bridge Entry Systems the control can be installed on the outside step.**



**For outside of Pool Bridge installation only.**

- The Step Bright controller allows you to either manually or automatically control the light.
- The low voltage connects to the power cord attached to the controller. Simply plug the cords together and tighten the locking ring connector.

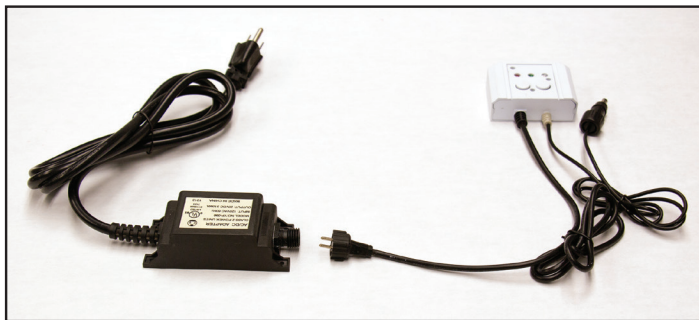
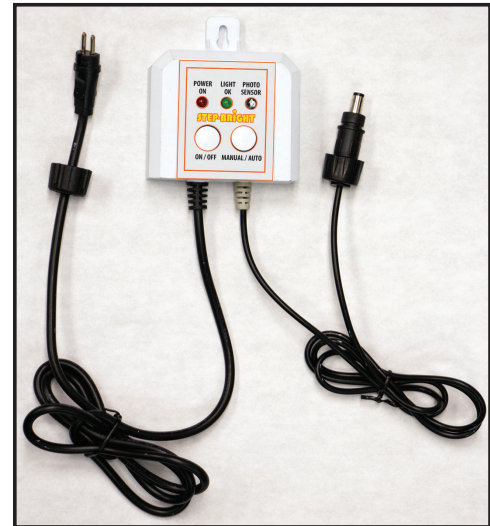

- The other cord coming from the controller (left side/ bottom) connects to the transformer cable the same way.
- The plug ends are different so you cannot connect the cables incorrectly.

- To power on you light press the on/off button on the control pad (transformer needs to be connected to power source)
- Once light is powered on select either manual operation or automatic operation by pressing the “manual/ auto” button.



- For manual operation — the Light OK indicator will illuminate.
- For automatic operation — light will turn on at sunset and off at dusk – the photo sensor indicator will illuminate.

**DANGER**

**WARNING**

To prevent  
Entrapment or  
Drowning,  
**DO NOT SWIM**  
through, behind  
or around the  
ladder

**DANGER**

**SAFETY  
NOTICE  
IMPORTANT**

**WARNING**

This ladder is  
designed and  
manufactured for  
**Aboveground,  
Semi-Inground  
Flat Bottom  
Pools**  
48", 52" and 54"  
in wall height  
and pool decks  
48", 52" and 54"  
in height

**WARNING**

**DANGER**

Entry/Exit of  
Pool,  
Face the  
Ladder at  
all times

**DANGER**

**PLEASE  
READ  
BEFORE  
USING  
THIS  
LADDER**



**Blue Torrent** manufactures all of its products using cutting-edge technology with the best materials and workmanship available.

**Blue Torrent's ENTRY SYSTEMS, LADDERS AND STEPS** are warranted as follows:

## **1 YEAR LIMITED WARRANTY**

**Blue Torrent** warrants its Entry Systems, Ladders and Steps to be free of defects in material and/or workmanship for a period of one year from the original date of purchase.

### **WARRANTY CLAIM EXCLUSIONS:**

- Damage caused by improper installation as specified in owner's manual
- Damage caused by improper handling
- Damage due to misuse, abuse and/or failure to operate item per owner's manual
- Damage caused by improper water chemistry
- Damage caused by improper winterization of equipment
- Damage caused by not using original replacement parts
- Accidental damage, fire, acts of God or other circumstances outside of **Blue Torrent's** control

#### **NOTE:**

- Customer must retain the original sales invoice as proof of purchase along
- Commercial facilities are not covered by warranty

Please return any and all defective items to your local authorized **Blue Torrent** dealer for inspection.

**The customer is responsible for all shipping charges to and from the nearest Factory Warranty Center. For more information. Please visit [www.btwarranty.com](http://www.btwarranty.com)**

Should a defect in material or workmanship appear the product will be repaired or replaced at our discretion. Neither **Blue Torrent** nor any authorized dealer is responsible for any charges related to the installation of the new item or part. Nor are they responsible for any incidental charges incurred including, but not limited to, water, chemicals, landscaping or any other associated expenses.